

The how-to magazine of electronics...

AN INTERTEC PUBLICATION <sup>TM</sup>

# ELECTRONIC

## Service & Technology

JANUARY 1988/\$2.25

1987 Article Index • Voltage Regulators

Service the Commodore 1541 Disk Drive

**Special report:  
Computer servicing**



A48414-----SLFBA7820 OCT88 ESQ  
G10203871060287123 GG 1  
GREG SELF ES  
9782 BANCROFT RD  
BANCROFT MI 48414

# More Functions. Smaller Budget.

## Beckman Industrial Circuitmate™ DMMs put hFE, Logic, Capacitance, Frequency and True RMS In Your Hand. For Less.

**Get more, for less. It's a simple definition of value.** For DMMs, value means finding the combination of capabilities that meets your needs at the right price. Without losing sight of accuracy and reliability. If you want more functions at a low price, Beckman Industrial's Circuitmate™ Digital Multimeters are the best value around.

From the pocket-sized DM20L to the DM850, with true RMS capability and accuracy to 0.05% ± 1 digit, Circuitmate DMMs give you the functions you need.

For instance, the DM20L puts both a Logic Probe, a transistor gain function (hFE), and a full range of DMM functions in the palm of your hand. For only \$79.95.

Then there's the DM25L. Where else does \$99.95 buy you a Logic Probe, capacitance measurement, transistor gain function (hFE), and 24 DMM ranges including resistance to 2000 megohms? Nowhere else.

When high accuracy counts, there's the DM800 with a 4 1/2 digit display. The DM800

### DM20L Pocket-Size w/Logic \$79.95\*

TTL Logic Probe: 20MHz  
Hi/lo/off indications  
Detects 25ns pulse widths

hFE (NPN or PNP):  
1 range (1000)

DMM: Input Impedance—  
10 Megohms  
DCA/ACA-5 ranges  
(200µA to 2A)

Ohms-8 ranges (200 ohms  
to 2000 Megohms)

Continuity beeper



also gives you frequency counting. A full-function DMM, and more, doesn't have to cost over \$195.00. If it's a Circuitmate DM800.

Or, for a few dollars more, get true RMS (AC coupled) to let you accurately measure non-sinusoidal AC waveforms, and all the capability of the DM800, in the DM850.

Of course, there's a whole range of Circuitmate DMMs and service test instruments, including the DM78 autoranger that

### DM850 True RMS

4 1/2 digits. DCV accuracy is .05% +3 digits

True RMS

Frequency counter to 200KHz

Data Hold display capability

Continuity beeper

Built-in bail

Anti-skid pads

Price: DM850 (True RMS) . . . \$219.95\*  
DM800 (Average) . . . \$195.00\*



fits in a shirt pocket, yet gives you a full size 3 1/2 digit, 3/8" readout. Not to mention a complete line of accessories like test leads, current clamps, even probes that can extend your DMMs range and sensitivity. All designed to work flawlessly with your Beckman Industrial Circuitmate DMM.

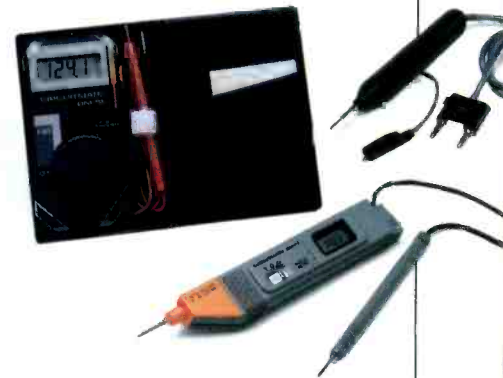

See your Beckman Industrial distributor and discover more DMM performance. For less.

\*Suggested list price (\$US) with battery, test leads and manual.

In Service Instruments,  
We're The One.

**Beckman Industrial™**

Beckman Industrial Corporation, Instrumentation Products Division  
A Subsidiary of Emerson Electric Company  
3885 Ruffin Road, San Diego, CA 92123-1898  
(619) 495-3200 • FAX: (619) 268-0172 • TLX: 249031  
© 1987 Beckman Industrial Corporation

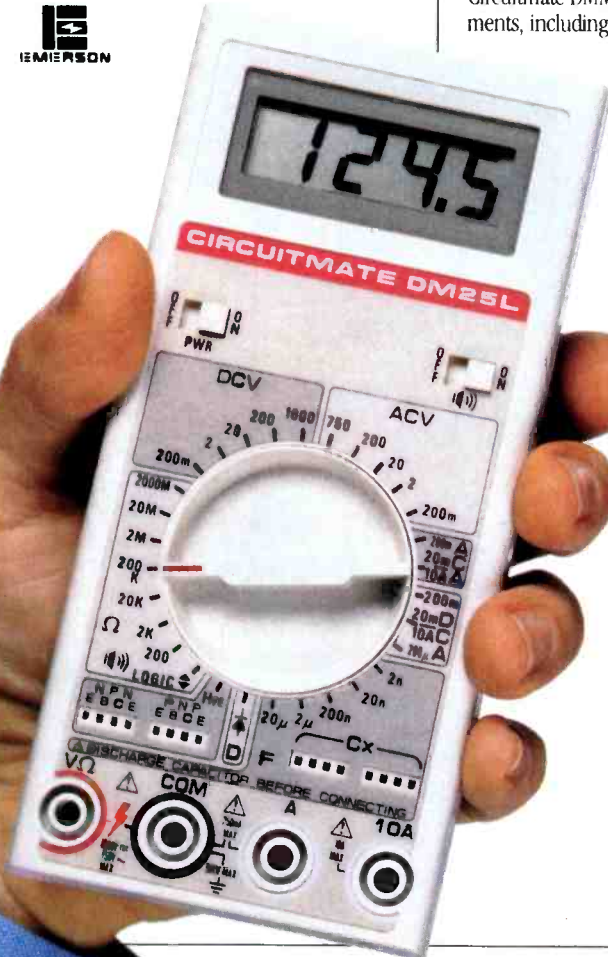

Circle (1) on Reply Card





# SEEK PROFESSIONAL HELP

Servicing electronic equipment isn't always easy, especially if you're doing it in the field. At Chemtronics we can help with over 200 specially engineered products for the maintenance, repair and production of high technology equipment. Call today for our latest problem solving catalog.

Circle (3) on Reply Card

**Chemtronics**  
Keeping pace with advanced technology

Chemtronics, Inc. 681 Old Willets Path, Hauppauge, NY 11788 800-645-5244 In NY 516-582-3322 Telex 968567

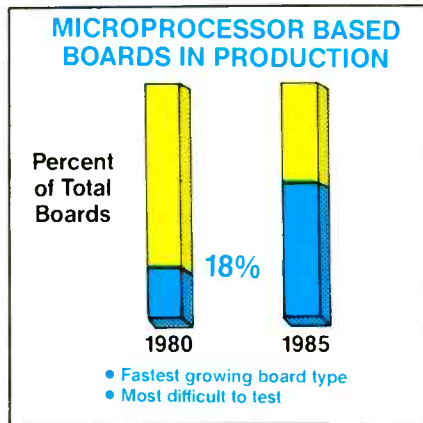

Page 16—Use of microprocessor-based boards in consumer equipment has risen dramatically in the last five years.



Page 52—A break-out box connected between a computer and a peripheral monitors the signals and helps determine the problem.



Page 54—This test system exercises a PC system through its I/O connections and tells the technicians which components to check.

## FEATURES

### 8 Voltage regulators

By Greg Carey, CET

This last part of a 3-part series on horizontal output circuits shows how to isolate problems related to the power supply and regulator circuits.

### 62 Index of 1987 articles

Need help using a piece of equipment or solving a servicing dilemma? The index may lead you right to the article you need.

## SPECIAL REPORT

### Computer servicing

### 15 Special report introduction

By Conrad Persson

As personal computer use grows, so will opportunities to service them. This special report shows you how to service specific products and what equipment to use.

### 16 Troubleshooting microprocessor-based circuits—Part I

By Tom Allen

This first part of a 2-part article discusses how microprocessor-based systems differ from analog or digital systems, and gives a run-down on the best equipment to use for this new application.

### 24 Servicing the Apple II + computer

By Michael J. Zoiss

Digital troubleshooting skills are as useful for computer servicing as they are for any other application. These five case histories of actual service experiences show how to apply these principles to the Apple II + computer.

### 49 Servicing the Commodore 1541 disk drive

By Andy Balogh

The 1541 is a good introduction to disk drive servicing because it uses common methods to store and retrieve data. However, there are a few tricks to this trade.

### 52 Break-out boxes: Active vs. passive

By Manfred R. Will and Cindi L. Kemper

The break-out box is a useful tool for testing serial interfaces between computers and peripherals, but whether to use an active device or a passive device depends on the situation.

### 54 Logic probes: Troubleshooting to the component level

By Conrad Persson

If troubleshooting to the PC-board level and replacing the problem board isn't the best solution, the logic probe may help you troubleshoot all the way to the component level.

## DEPARTMENTS

### 4 Editorial

### 6 News

### 14 Products

### 35 Profax

### 54 What do you know about electronics?

We get letters

### 60 Test your electronics knowledge

### 67 Literature

### 68 Audio Corner

More on audio servos

### 70 Computer Corner

Accessing read-only memory

### 72 Video Corner

Operation of the Newvicon pickup tube

### 74 Readers' Exchange

### 76 Advertisers' Index

## ON THE COVER

As uses for computers increase and prices decrease, sales of personal computers to consumers should rise, along with opportunities to service PCs. The 3.8 million PCs sold for home use, as reported by the EIA, attest to the profitable future of computer servicing. (Photo courtesy of Beckman Industrial.)

The how-to magazine of electronics

**ELECTRONIC**  
Servicing & Technology



# LEADER



**Our counters lead a shielded life.**

Leader gives you virtually total protection from EMI and RFI, because Leader frequency counters come in all-metal housings. Leader also gives you remarkable accuracy and stability—our 1-GHz counter is accurate to 0.03 parts per million  $\pm 1$  digit. And that's over the entire temperature range of 0° to 40°C.

With large, bright displays, 20-mV sensitivity, and choice of gate times, Leader frequency counters are the right choice.

Built tough to endure the rigors of 3-shift production operations and the roughest handling by service technicians and students, Leader counters function perfectly under severe environmental conditions that would destroy ordinary counters.

That's why we give them two-year warranties.

See the Leader difference. Ask for our catalog, an evaluation unit and the name of your nearest "Select" Leader distributor.

LDC-825  
8-digit Frequency Counter  
**1 GHz**

ACTUAL SIZE



LDC-824S  
8-digit Frequency Counter  
**520 MHz**

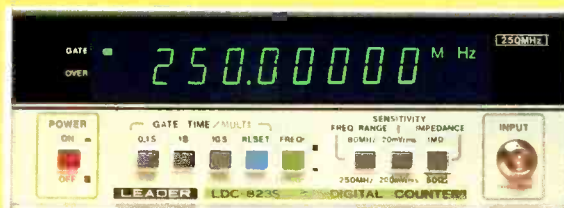

LDC-823S  
8-digit Frequency Counter  
**250 MHz**

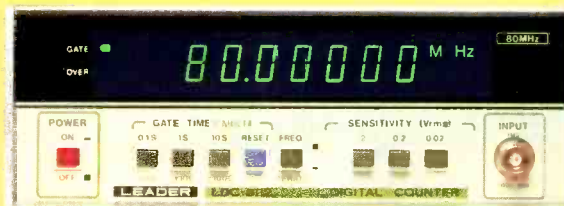

LDC-822  
7-digit Frequency Counter  
**80 MHz**

Call toll-free  
**(800) 645-5104**

In New York State  
**(516) 231-6900**

For professionals who know the difference.

**LEADER**  
Instruments Corporation

380 Oser Avenue  
Hauppauge, New York 11788  
Regional Offices:  
Chicago, Dallas, Los Angeles, Boston  
In Canada call Omnitrax Ltd.  
(514) 337-9500

For Information Circle (4) on Reply Card  
For Demonstration Circle (46) on Reply Card

# The new ES&T

Happy New Year, and welcome to a new modern look for **Electronic Servicing & Technology**.

We figured you couldn't help but notice that we have a new look, so we might as well call attention to it. We have made a number of changes, all of which are designed to make the magazine both more attractive and easier to read.

For starters, we changed the typeface. For those of you who are into type, for years our magazine was printed in a typeface called "Century." Starting with this issue, we will be printing the magazine in a typeface called "English Times." We didn't make the change just to make the magazine look different. The only reason we changed the typeface is that English Times is much easier to read.

You'll also note that we've changed the heads of the departments—News, Books, Products, etc. Again, we didn't make the change just for the fun of it. We felt that this change would make the pages look more consistent and streamlined, and, again, it will make the magazine easier to read.

Finally, we've changed the table of contents in a way that we feel not only makes it more attractive, but will help you find the articles that interest you more easily. We've also made a few other subtle changes throughout the magazine, but I won't detail them all here.

Most important, the change in the look of the magazine doesn't signal any change in the content. We are still the how-to magazine of consumer electron-

ics servicing, and that's what we will continue to be.

## Thanks for responding

In our September issue, we included a reader opinion survey in which we asked for information about you and your opinions about the magazine. To the 420 of you who took the time to fill out the card and return it to us, thank you. The information will be extremely valuable to us in planning future issues. Here's a sample of what those people who responded told us. (Please keep in mind that the numbers and percentages reported apply only to those 420 people who responded and, because of the nature of the survey, can't be considered to be representative of all of the readers of the magazine.)

I won't burden you with all of the results here, but the information that we found most useful came from the responses to the questions, "What kind of information do you want to read about in **ES&T**?" and "What kind of information is the *most* useful to you?"

Although these numbers are not considered statistically significant because the survey sample was not selected on a scientific basis, they are in line with the kind of feedback we have been getting from readers through other methods, and so we will use this as one of the information sources on which to base decisions for future article coverage. That means lots of TV and VCR servicing articles, and significant coverage of audio, CD and computers.

*Nile Conrad Perren*

Type of information	Want to read about	Found most useful
TV servicing	86.7%	60.7%
VCR servicing	83.6%	45.7%
Audio servicing	66.2%	23.3%
CD servicing	50.2%	12.1%
Computer servicing	49.3%	21%





PHILIPS

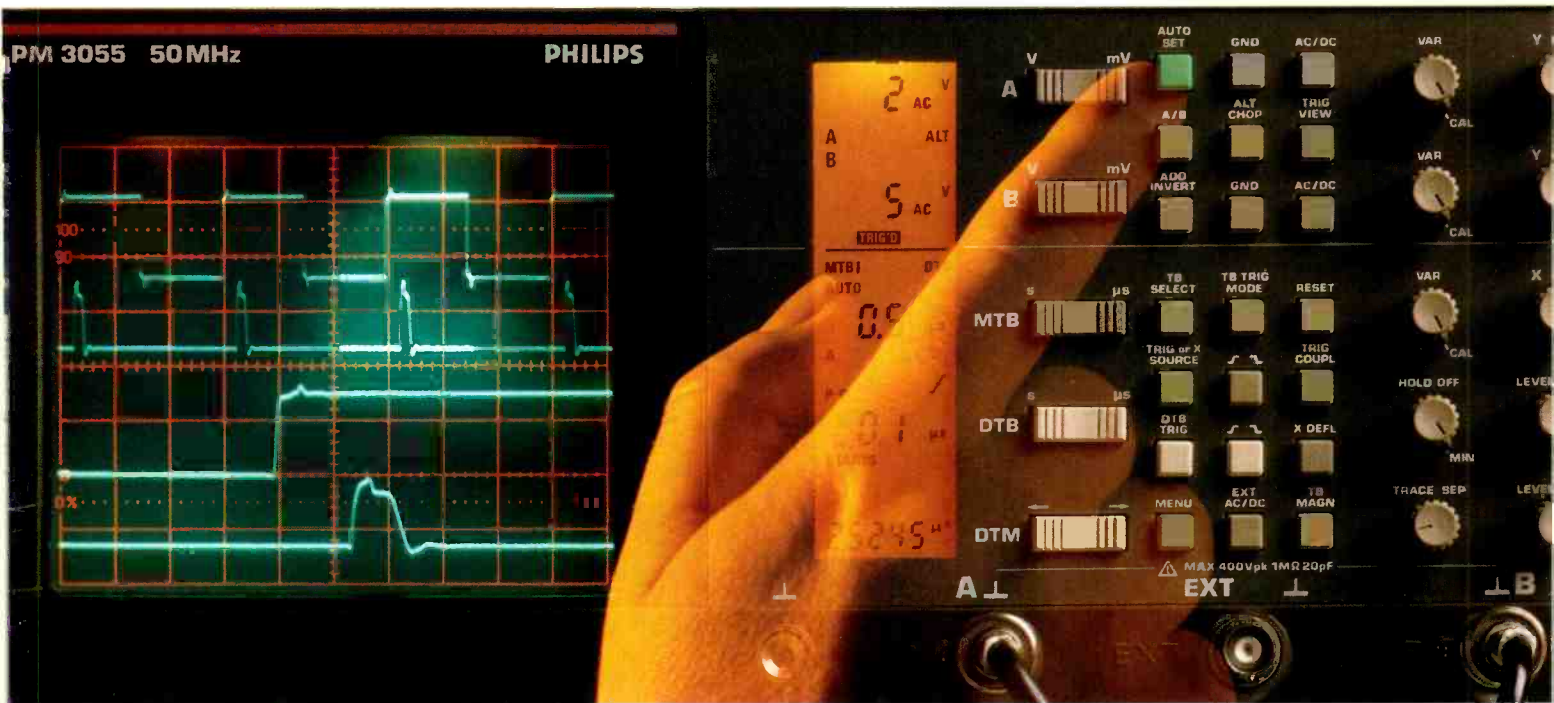

# The smart scope for people who hate to wait

**The Philips microcomputer-controlled PM 3050 Series. The only 50 MHz scopes in the world smart enough to find and display the signal—automatically.**

## SMART PERFORMANCE

- *Autoset finds the signal at the touch of a button.* Philips' intelligent beamfinder automatically selects amplitude, timebase and triggering for error-free instant display of any input signal on any channel.
- *16kV CRT for optimum viewing.* When it comes to brilliance, clarity and spot quality, nothing in its class shines brighter.
- *LCD Panel for confident, at-a-glance operation.* A valuable information center, it instantly displays all instrument settings and parameter values. With no mistakes.

- *Auto-Triggering "thinks for you".* This built-in intelligence provides fast, accurate, properly-triggered signals up to 100 MHz.
- *IEEE Compatibility.* The PM 3050 Series is the only family of 50 MHz scopes with an add-on IEEE-488 interface option for fast computer hook-up.

- *Choice of Models.* Single timebase or delayed sweep versions are available.

## SMART SUPPORT

Philips PM 3050 Series also comes with a 3-year warranty and all the technical and service assistance you need. From Fluke—the people who believe that extraordinary technology deserves extraordinary support.

## SMART BUY

For about what you'd pay for the next-best scope you get innovative engineering that's

more productive and easier to use. You get plug-in modularity and IC microelectronics for reliability you've never seen in this class before. Plus, for a limited time, you get a no-risk, no-questions-asked, 30-day money-back guarantee. So why wait any longer?

## TEST THE DIFFERENCE

So call Fluke today at **800-44-FLUKE ext. 77**. And find out how smart your next oscilloscope buy can be.

John Fluke Mfg. Co., Inc., P.O. Box C9090, M/S 250C, Everett, WA, 98206  
U.S.: 206-356-5400 CANADA: 416-890-7600  
OTHER COUNTRIES 206-356-5500

© Copyright 1987 John Fluke Mfg. Co., Inc.  
All rights reserved. Ad No. 1075-P305X



PM 3050/55 • 50 MHz • OSCILLOSCOPES



Circle (5) on Reply Card

## NASD offers seminars

NASD (National Association of Service Dealers) is offering seminars geared toward owners and managers of product sales, rent-to-own and rental businesses. During a typical 1-day, 7-hour program, participants listen to in-depth discussions about financial planning, service advertising, strategic planning and customer relations. The 2-day, 14-hour service seminars cover the same topics more in depth.

NASD will also be sponsoring its School of Service Management in Daytona Beach, FL, February 6-9, at the Indigo Lakes Resort and Conference Center.

Anyone interested in more information on NASD's programs may contact NASD at 10 E. 22nd St., Lombard, IL 60148; 302-953-8950.

## Maxtec completes buyout

Maxtec International has completed its buyout of Dynascan's Industrial Electronic Products Group. Maxtec was created by the management of Dynascan's former B&K-Precision test instruments and Telemotive industrial remote-control groups, which are both now part of Maxtec. Maxtec has signed

a multi-year lease with Dynascan to remain in its existing Chicago facilities. All the company's Telemotive products are manufactured in Chicago. About 60% of the B&K-Precision products are manufactured in Chicago.

## MTS TV sales rise in '87

Sales to dealers of color televisions with integral MTS rose almost 40% in 1987 compared to 1986, according to the Electronic Industries Association (EIA). As of the end of October, 3,448,934 were sold in 1987, compared to 2,468,058 in October 1986.

## EIA/CES prepare for Winter Show

More than 100,000 trade attendees are expected to travel to Las Vegas for the International Winter Consumer Electronics show, to be held Thursday, Jan. 7, through Sunday, Jan 10. The show will feature 1,400 exhibitors stationed in the Las Vegas Convention Center, the Hilton, the Riviera and the Sahara hotels.

Exhibits will showcase audio and video, computers and games, specialty audio, mobile electronics,

cellular phones, home and auto security, watches and calculators.

Highlights of the show will include the Opening Session, which will discuss industry prospects and the national economic outlook for '88; a Workshop Program, which includes sessions on DAT and high-definition television; an Advertising and Promotion Showcase; Publications and Trade Association Exhibits, featuring consumer electronics associations and publications; and the Electronic Product Locator, which will help attendees locate the products and companies in which they are interested.

## Correction

The telephone number for Applied Research and Technology was listed incorrectly in the article "Power Conditioning," which appeared in the November 1987 issue. ART's correct address and telephone number are: The Pavillion, Suite 201, 5770 Powers Ferry Road N.W., Atlanta, GA 30327-4390; 800-624-4115 or 404-951-9556.

**ES&T**<sub>INC.</sub>

The how-to magazine of electronics

# ELECTRONIC

*Servicing & Technology*

Editorial, advertising and circulation correspondence should be addressed to: P.O. Box 12901, Overland Park, KS 66212-9981 (a suburb of Kansas City, MO); (913) 888-4664. Home office fax: 913-888-7243; Home office telex: 42-4156 INTERTEC OLPK

## EDITORIAL

Nils Conrad Persson, *Editor*  
Carl Babcoke, *Consumer Servicing Consultant*  
Tom Cook, *Senior Managing Editor*  
Alisa Carter, *Associate Editor*  
Joy Culver, *Editorial Assistant*  
Darryll Fortune, *Editorial Assistant*  
Darren Sextro, *Editorial Assistant*

## CONSULTING EDITORS

Homer L. Davidson, *TV Servicing Consultant*  
Christopher H. Fenton, *Circuit Fabrication Consultant*  
Victor Meeldijk, *Components Consultant*  
Kirk G. Vistain, *Audio Consultant*  
Sam Wilson, *Electronics Theory Consultant*

## ART

Kevin Callahan, *Art Director*  
Barbara Miles, *Graphic Designer*

## BUSINESS

Cameron Bishop, *Group Vice President*  
Eric Jacobson, *Publisher*  
Greg Garrison, *Sales Manager*  
Stephanie Hanaway, *Promotions Manager*  
Kelly Hawthorne, *Promotions Coordinator*  
Dee Unger, *Advertising Supervisor*  
Catherine Grawe, *Advertising Coordinator*

## ADVERTISING

*Regional advertising sales offices are listed in classified pages.*

## ADMINISTRATION

R. J. Hancock, *President*  
Doug Riemer, *Circulation Vice President*  
Jane J. Powell, *Circulation Manager*  
Jo Ann DeSmet, *Fulfillment Manager*  
Barbara Clare, *Reader Correspondent*

**ELECTRONIC SERVICING & TECHNOLOGY** is the "how-to" magazine for technicians who service consumer electronics equipment. This includes service technicians, field service personnel and avid servicing enthusiasts, who repair and maintain audio, video, computer and other consumer electronics equipment.

**SUBSCRIPTION PRICES:** one year \$18, two years \$30 in the USA and its possessions. Foreign countries: one year \$22, two years \$34. Single copy price \$2.25; back copies \$3.00. Adjustment necessitated by subscription termination to single copy rate. Allow 6 to 8 weeks for new subscriptions.

**PHOTOCOPY RIGHTS:** Permission to photocopy for internal or personal use is granted by Intertec Publishing Corp. for libraries and others registered with Copyright Clearance Center (CCC), provided the base fee of \$2 per copy of article is paid directly to CCC, 21 Congress St., Salem, MA 01970. Special requests should be addressed to Eric Jacobson, publisher. ISSN 0278-9922 \$2.00 + 0.00



Member, Audit Bureau of Circulation



Member, American Business Press



Member, Electronic Servicing Dealers Association

**INTERTEC**  
PUBLISHING CORPORATION

©1988 All rights reserved.



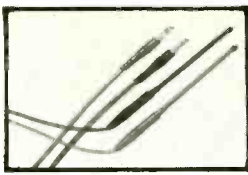

Circle (47) on Reply Card

**NEW SMD OSCILLOSCOPE PROBES AND TEST PROD KITS** O.K. Industries introduces SMD oscilloscope probes and test prod kits. The SMD Oscilloscope Probes, designated the PP5000 Series, are slim, precision probes designed for testing SMD circuits. The 0.8mm tip and slim-body probe allow improved viewing angles necessary for testing circuitry.

Specifications range from 30MHz to 275MHz, x1 and x10 attenuation and are available with readout actuators.

The new SMD tweezer prod kits, designated the TW300 (BNC connector) & TW300/BN (banana cable connector), for SMD testing can adapt to most multimeters. The tip contact is gold plated beryllium copper, the rating is 400Vrms, 3A and the cable length is 1.2 meters.

The TPK110 Test Prod Kit features ultra-thin test prods to maximize tester viewing angles. The rating is 250Vrms, 3A, the tip is made of stainless steel at 0.8mm and the cable length is 1 meter.

List price for probes starts at \$52.00. List price for Test Prods and Tweezers starts at \$13.95 for tweezers and \$24.95 for test prods.

Contact: O.K. Industries Inc., 1-800-523-0667. (In N.Y.S. call (914) 969-6800.)

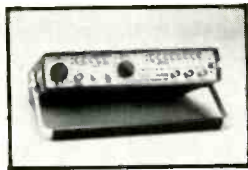

Circle (50) on Reply Card

**BATTERY POWERED DIGITAL STORAGE UNIT**

O.K. Industries Inc. introduces an all new battery operated, ultra portable instrument providing A/D conversion and up to 1K memory storage in a hand-held, 2 lbs. package. Designated the DS2202 this Digital Storage Unit is powered by four 1.5V "C" cell batteries. The DS2202 has a real-time bandwidth of 200kHz and is AC or DC coupled with 0% or 50% pre-trigger selection, single shot, role or refresh modes. The units non-volatile memory can store waveforms up to four years. The vertical sensitivity is 5mV/division and has 8 bit resolution. The DS2202 has an analog plot output of .02V/div. The unit can interface with any oscilloscope and sells for less than \$500.00.

A wide range of optional precision oscilloscope probes with bandwidths to 350MHz are also available.

Contact: O.K. Industries Inc., 1-800-523-0667 (In N.Y.S. call (914) 969-6800.)

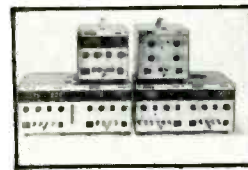

Circle (51) on Reply Card

**PRECISION BENCH TOP, LABORATORY POWER SUPPLIES**

The PS732 Series have dual 3 1/2 digit display for simultaneous metering of current and voltage. Output controls provide 0.1% accuracy for voltage readings and 0.3% accuracy for current readings. Moreover, where as typical 3 1/2 displays reduce resolution and in effect lose the advantage of high accuracy output, the PS732 series 3 1/2 digit display provides resolution to 0.01V and 0.001A over the entire range. The result is excellent accuracy and resolution providing true precision output.

A front panel switch provides rapid and exacting set up of current limits without manually shorting the outputs and without having to place the circuit under load. The PS732 Series can operate in constant current or constant voltage modes. The display provides a clear indication when the supply crosses over from constant voltage to constant current.

Specifications are as follows:

PS732	Single Output	0-30V/0-2A
PS732-Q	Dual Output/Quad Mode	2X0-30V/0-2A or 0-30V/0-4A or 0-60V/0-2A or 0 ± 30V/2A
PS732-K	Triple Output	0-30V/0-2A & 0-30V/0.1A & +5V/7A

Prices start as low as \$345.00. Contact: O.K. Industries Inc., 1-800-523-0667/914-969-6800 (NYS).



Circle (48) on Reply Card

**NEW SMD REMOVAL UNIT** O.K. Industries Inc. introduces a new Hot Tweezer System. Designated the SMT-W2, this powerful unit features variable temperature and high reliability.

The SMT-W2 incorporates an ergonomically designed handpiece which can be comfortably held by any operator regardless of hand size. Two eight watt ceramic heating elements provide exceptional temperature stability and sufficient power to remove any SMD from chip to resistors large quad packs.

A full range of tips are available including 5mm tips for resistors or capacitors, mini-flats or SOIC's and right angle tips for PLCC's to 84 pins.

List price is \$425.00.

Contact: O.K. Industries Inc., 1-800-523-0667. (In N.Y.S. call (914) 969-6800.)



Circle (49) on Reply Card

**INDUSTRIAL POWER SOLDERING IRONS** O.K. Industries introduces a new industrial power soldering iron series. Designated the New SA-8 Series, these irons are extremely slim, light weight, ergonomically designed, production quality irons.

These irons offer: • highly accurate temperature stability which prevents damage to boards and components • quick heat up time with rapid temperature recovery • silicone rubber heat guard which provides operator comfort and a positive grip for safety • long-life corrosion resistant tip • grounded tip for CMOS safe soldering.

The SA-8 Series solder irons have a maximum equivalent rating of 30, 40 and 50 watts. All irons have a three wire grounded power cord.

Prices start as low as \$24.95.

Contact: O.K. Industries Inc., 1-800-523-0667 or (914) 969-6800 (NYS).

# Uncontrolled...

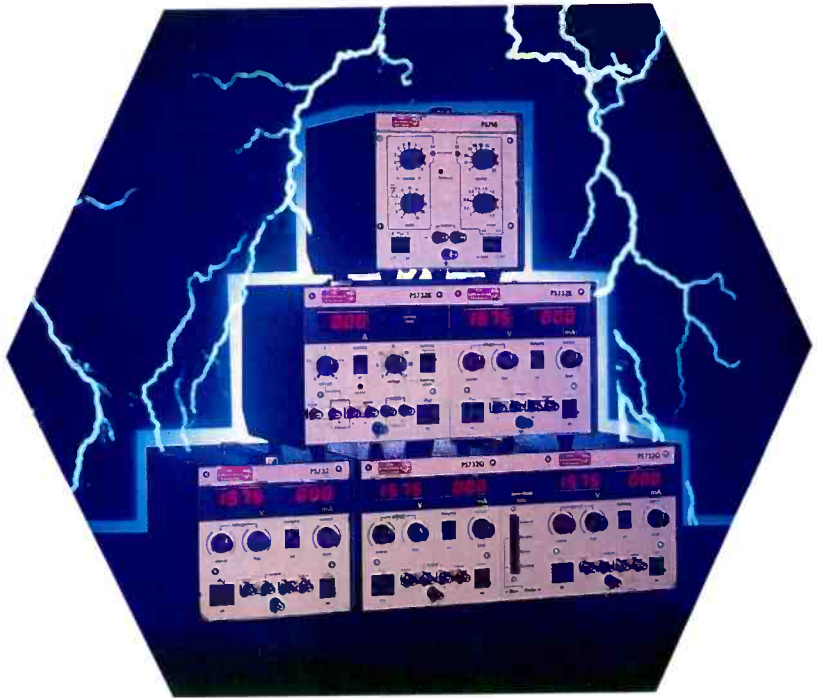

static discharge is no substitute for precisely controlled voltage and current output. Our new PS700 Series power supplies have dual simultaneous voltage and current displays. Both levels are exactly set-up **before** the load is applied. Single, dual, and triple output units are available.

The dual output PS732-Q has push-button selection of isolated, true parallel, series and series tracking modes. The triple output PS732-K features a third variable  $\pm 5V/0-7A$  output in addition to the standard 0-30V/0-2A outputs on all units.

Outstanding quality from precision control.

**CALL OK TODAY**

**800 523-0667**

**IN NEW YORK STATE DIAL (914) 969-6800**

**BEING THE BEST IS A MATTER OF BEING OK.**



4 Executive Plaza, Yonkers, New York 10701 USA  
Telex 125091 OK NYK Telex 232395 OK NY UR  
Phone (914) 969-6800  
Fax (914) 969-6650



Circle (8) on Reply Card

# Servicing voltage regulators

If the main voltage malfunctions, it may keep the set from starting up, or it may cause the set to shut down. Here's how to determine if the regulator is the culprit.

By Gregory D. Carey, CET

This is the last of a 3-part series dealing with the horizontal output circuits of modern TV receivers. Part I explained how shutdown circuits operate and the best way to find the cause of shutdown. Part II discussed what to do if the circuits never get started in the first place. This time, we'll see how to isolate problems related to the power supply and regulator circuits. Combining all three should help you isolate any problem related to the output stages.

The first two installments of this series described how to troubleshoot problems in the startup and the safety shutdown circuits in modern TV receivers. This article will explain how the main voltage

regulator can cause a shutdown or a startup problem. The first section explains how the troubleshooting from the first two articles isolates regulator problems. The second section explains how various kinds of regulators work. See Figure 1 for a diagram of the three loops that must work correctly for a modern TV set to operate.

## How the regulator causes shutdown

The regulator is often the cause of shutdown. If it applies too high a voltage to the output transistor, the high voltage and the yoke current can climb too high. One of the safety detectors should sense this and cause a shutdown circuit to kill the horizontal output circuits.

The first article states that the best way to identify the cause of a shutdown is to monitor the collector of the horizontal output stage when you first ap-

ply power to the receiver. This calls for test equipment with enough protection to monitor voltages as high as 1,200V.

When the horizontal circuits operate correctly, the voltage reading at the collector should be the regulated dc level specified on the schematic. It should also have pulses, about  $12\mu\text{s}$  wide, that repeat every  $63.5\mu\text{s}$ . The pulse amplitude varies from one receiver to the next, but it is normally between  $700\text{V}_{\text{p-p}}$  and  $1,200\text{V}_{\text{p-p}}$ . A chassis with a shutdown problem produces flyback pulses until the safety circuits take over. The circuits either shut down the ac drive to the output transistor or its dc power supply.

After confirming a shutdown, separate the regulator from other possible problems. Reduce the ac line voltage to less than 90V with an isolated, adjustable ac power supply. The lowered voltage reduces the dc at the regulator input to a voltage below its normal output. Because the regulator cannot boost the voltage, this gives you manual control of the voltage powering the output stage. (See Figure 2.)

If the set operates at this lower voltage level, you can make some tests on the collector signal to eliminate ac conditions as the cause of the problem. If the scope CRT shows that the flyback pulse is less than  $12\mu\text{s}$ , for example, a capacitor between the emitter and collector of the output stage is probably open. If the pulse is poorly shaped, suspect a bad flyback or a shorted flyback load. If the pulse has the correct waveshape, monitor it while increasing the ac line voltage.

Now, monitor the dc level while you observe the flyback pulse. The dc should increase as you raise the ac line voltage until it reaches its normal out-

Carey is an application engineer at Sencore. He has run more than 800 seminars for service dealers.

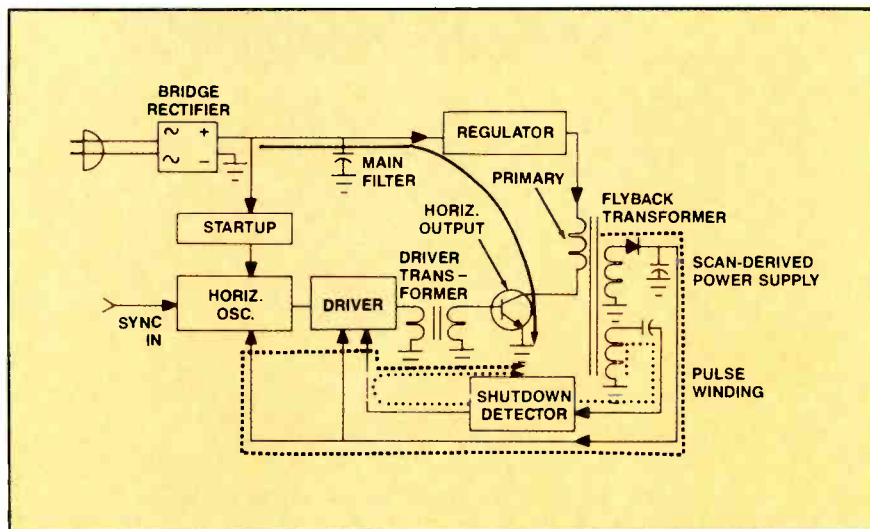

Figure 1. For the horizontal circuits to operate, three loops must work correctly: the main power loop (solid line), the scan-derived loop with its startup circuits (dashed line), and the safety shutdown loop (dotted line). (Schematic courtesy of Sencore.)



# Now! 100 MHz. Cursors. CRT readout. Four channels. All for just \$2400.

The NEW Tek 2246 and 2245 set the pace in fast, accurate measurement. And immediate, easy delivery. Take a close look. At their unmatched price/performance. At versatile, on-site-at-bench convenience. At Tek SmartCursors™ a 2246 exclusive. All backed by a 3-year warranty and 30-day free trial on approved credit. Don't settle for less. Get out in front with scopes that set the pace. Return the

card or call Tek direct:  
**1-800-426-2200**



Features	2246	2245
Bandwidth	100 MHz	100 MHz
No. of Channels	4	4
SmartCursors™	Yes	No
Time/Volts Cursors	Yes	No
Voltmeter	Yes	No
Scale Factor Readout	Yes	Yes
Vertical Sensitivity	2 mV/div	2 mV/div
Max. Sweep Speed	2 ns/div	2 ns/div
Accuracy: Vert/Hor	2%/2%	2%/2%
Warranty	3-year on parts and labor, including CRT	
Price	\$2400	\$1775



- 1 Smart-Cursors™ track trigger level, ground level or peak voltages.
- 2 CRT readout of scale factors and results.
- 3 Menu functions controlled by top row of push-buttons.
- 4 Gated voltage mode intensifies the portion of a waveform on which voltage measurements are being made.
- 5 Versatile triggering lets you trigger the main or delayed sweep.
- 6 Backlit control buttons.

**Tektronix®**  
COMMITTED TO EXCELLENCE

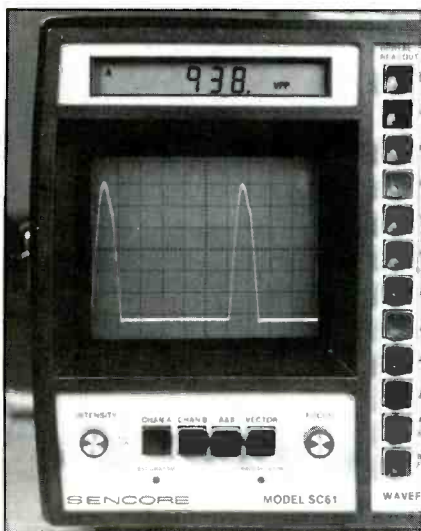

**Figure 2.** Use an adjustable, isolated ac power supply to reduce the voltage to the receiver. This gives you manual control of the voltage regulator, which lets you find what is causing the circuit problem.

put voltage. If it continues to increase beyond the normal level, you know that a bad regulator is causing the shutdown.

### How the regulator prevents startup

The regulator also can be the cause of a startup problem if its output is too low to operate the output stage. To further complicate matters, some receivers



**Figure 3.** Set the scope's input coupling switch to "DC" to tell whether power is still present immediately after it is applied. If so, the line will move from the position set before applying power. If your scope has a digital readout, use it to confirm the correct dc level.

use a shutdown circuit that kills the regulator, which makes it important to monitor the collector of the output stage from the very first moment power is applied.

A dc-coupled oscilloscope lets you test for dc during the first few seconds. Before applying power, set the scope's input coupling switch to dc and set the trace position near the bottom of the scope face. Set the vertical attenuator to the highest volts per division setting.

You know that dc was present if the trace moves up from its resting position when you apply power. If the trace then settles back to its original position, the regulator has gone into shutdown. If your scope can monitor the dc level digitally, use it to check the resulting voltage after the initial excitement dies down. Also, watch for flyback pulses. If they build and then collapse, the set started and was then shut down. (See Figure 3.)

Any dc you measure at the collector while the set is shut down can be misleading. The voltage usually will be too high because the output stage is not drawing current. Reducing the voltage and then increasing it slowly lets you confirm whether the regulator is working while the output stage is pulling power.

Now that you know how the regulator can cause shutdown or startup problems, let's look inside several typical

regulator circuits to learn better ways to troubleshoot them.

### Nothing beats a zener

Nearly all voltage regulators use a zener diode as a reference. The zener, however, needs some help to control the high power used by a TV output stage. Before we look at the helper circuits, let's review how a zener regulates. (See Figure 4.)

When reverse biased, a zener acts like an open circuit as long as the voltage across it stays below its breakdown level. If the voltage exceeds the zener's rating, it begins to draw more current in an attempt to hold the voltage across it to a fixed level. As the current increases, the diode dissipates the excessive power as heat. If too much current flows for too long, the heat destroys the diode.

The circuit that uses the zener needs to limit the maximum current to prevent the zener from burning out. Most circuits use a series resistor. The resistor and the zener then form a voltage divider, with the difference between the zener voltage and the raw supply voltage dropping across the series resistor.

Some small power supplies use a zener as the sole regulator. There are, however, two limits to the zener regulator. First, the zener runs out of regulation range if the power dissipated by the load is equal to or greater than the zener's power rating. This power limitation worsens if the power drawn by the load varies greatly. The zener/resistor regulator also does not work well if there are large variations in the applied voltage, because the series resistor always drops some voltage, even if the zener is not conducting.

A television has all these conditions. The television draws 100W or more, depending on many variables, including the brightness of the picture and the loudness of the audio. Moreover, ac line voltages may change from 90V to 130V

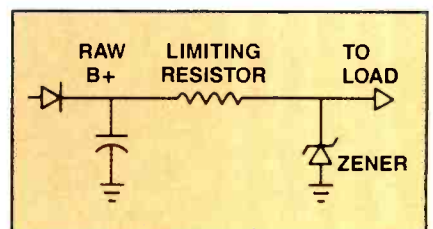

**Figure 4.** Zener diodes can be used as a regulator as long as the load has low power requirements and the input voltage does not vary over too wide of a range. (Schematic courtesy of Sencore.)



# SPIKES, SAGS & SURGES

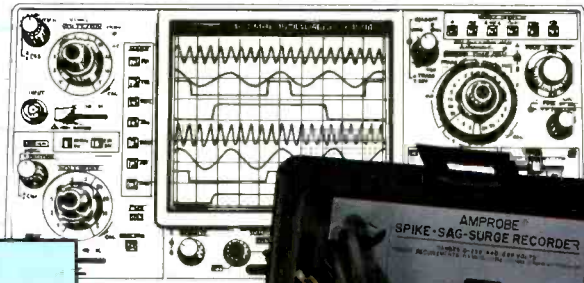
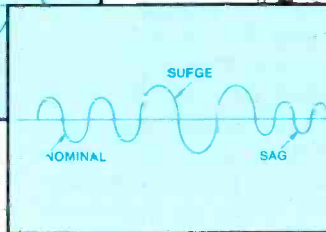
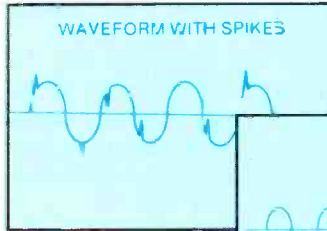

You need a tool to identify these disturbances before they cause a problem.

You need our new line disturbance recorder:

## AMPROBE® SPIKE-SAG-SURGE RECORDER

- Solid State Circuit Design
- Easy to use, affordable
- All 3 disturbances appear on same chart
- Low Battery Indication

Ranges are 220/440/880V nominal.  
User adjustable threshold.



MODEL  
LAS-800  
\$699.85

Available in well over 100 countries around the world.



Write for Catalog AAD-86 or visit your Amprobe distributor today.

Circle (7) on Reply Card





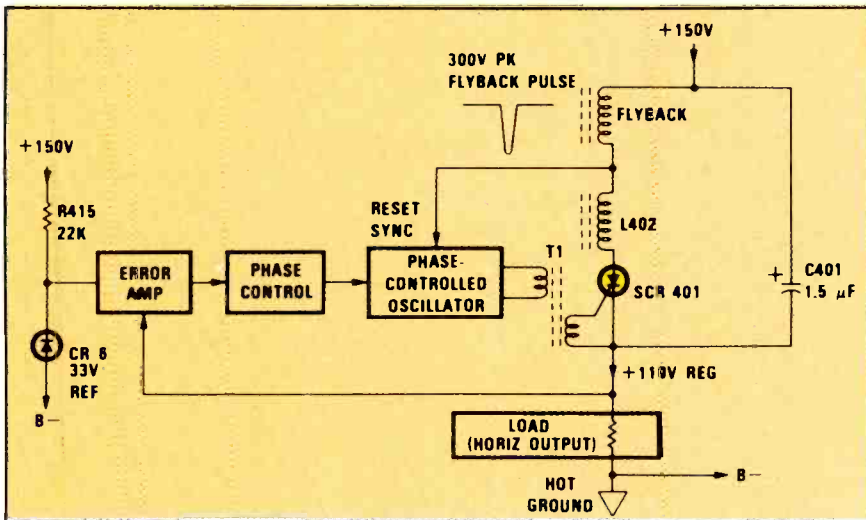

**Figure 7.** This SCR regulator is more efficient than a power transistor because much less power is wasted as heat. The oscillator fires the SCR at different times during horizontal trace time, depending on the amount of power needed. Firing the SCR earlier provides higher power. (Schematic courtesy of RCA.)

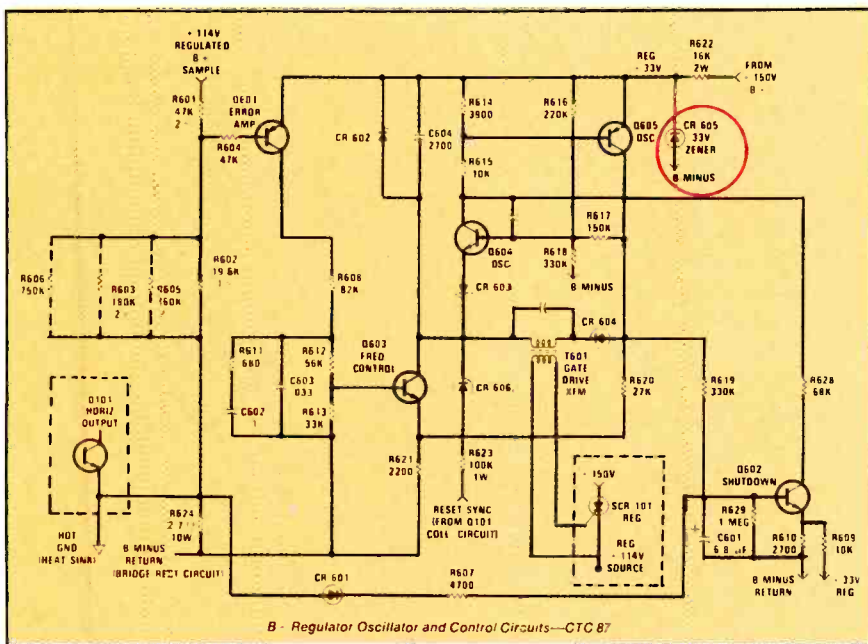

**Figure 8.** This schematic shows an actual regulator oscillator and driver. Notice that an accurate zener still serves as the main voltage reference. (Schematic courtesy of RCA.)

ulated output to a precision zener diode to determine this timing. (See Figure 8.)

Once the SCR is fired, it will stay on until the voltage between its anode and cathode drops to zero. An extra flyback winding, wired in series with the SCR, provides a pulse to turn off the SCR. The flyback pulse reverse-biases the SCR during each time the beam retraces. The SCR remains off until the oscillator turns it on, sometime during the trace time.

Startup and shutdown problems are tough to find because of the way the circuits operate. A shutdown happens so

fast that it often looks like a startup problem. Three closed loops intertwine, which turns your troubleshooting into a wild goose chase. Voltage regulator problems can also cause either type of problem.

Two techniques solve these problems. First, watch the collector of the output transistor to monitor both ac and dc conditions during the first few seconds of operation. Second, reduce the ac line voltage so that you have manual control over the regulator circuits. Then, move slowly through the circuits until you've isolated the problem.



## HITACHI SCOPES

**15-25% Discount**



**V1060**  
**100MHz**  
**\$1375**

V660 60MHz Dual Trace **\$990**  
V422 40MHz Dual Trace **\$699**  
V212 20MHz Dual Trace **\$475**

## ELENCO PRODUCTS AT DISCOUNT PRICES!



**\$498**  
**MO-1252**

### Scopes

MO-1253 40MHz Dual Trace **\$550**  
Delayed Sweep 12KV HV, More  
MO-1252 35MHz Dual Trace **\$498**  
MO-1251 20MHz Dual Trace **\$349**  
w/ Two 1x, 10x 100MHz probes, manual  
S-3000 10MHz fully calibrated **\$239**

### GF-8016 Function Generator with Freq. Counter



**\$239.95**

Sine, Square, Triangle  
Pulse, Ramp, .2 to 2MHz  
Frequency .1 thru 10MHz

**GF-8015 without Freq. Meter \$179**

### Digital Triple Power Supply

**Model XP-765 \$239.95**



0-20V @ 1A  
0-20V @ 1A  
5V @ 5A

Fully Regulated, Short Circuit Protected  
with 2 Limit Cont. 3 Separate Supplies  
**XP-660 w/ Analog Meters \$169.95**

### Color Convergence Generator



**SG-200**  
**\$69.95**

Finest in the industry  
10 rock steady patterns

### Digital LCR Meter

**\$138.95**

**Model LC-1800**

Measures Inductors,  
Capacitors,  
Resistors



### Multimeter with Cap. and Trans. Tester

**\$59.95**

**Model CM-1500A**

8 Functions  
with Case



**C&S Sales Inc.,** 1245 Rosewood  
Deerfield, IL 60015 (312) 541-0710  
800-292-7711 ASK FOR CATALOG

15 Day Money Back Guarantee  
2 Year Limited Guarantee  
Add 5% for Postage (\$10 max)  
IL Res., 7% Tax



Circle (14) on Reply Card

## Interface testers

Nu Data has announced three interface break-out testers. The models 9200, 9230 and 9240 meet the new RS-232 D specification and have dual pulse traps, positive and negative source voltages and 2-3/3-2 reversal for instant null modem configurations.

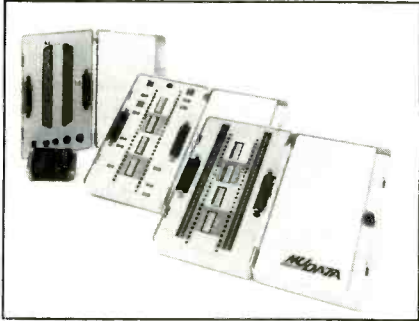

The model 9200 features a quad-state design with 100 LEDs to monitor signals from both sides of the interface. The models 9230 (interface powered) and 9240 (high-impedance) monitor the quad-state condition of the 11 major interface signals, with a spare LED pair for monitoring remaining signals.

The 9200 also tests IBM parallel interfaces and RS232 (or parallel) cables that use DB25 connectors. The 9230 and 9240 feature control lead activating switches for RTS, CTS, DSR and DTR.

Nu Data also has introduced the model 9500 25-pin cable tester that features auto scan, auto shut-off, manual step and a built-in audible continuity tester.

Circle (75) on Reply Card

## Logic analyzer/oscilloscope

*Bitwise* has introduced the Analog Pod to its Logic-20 family of PC-based logic analyzers. The analog pod enables simultaneous analysis of analog and digital signals within the same circuits, allowing any Logic-20 unit to function as a logic analyzer and digital storage oscilloscope. Key features include 20MHz synchronous or asynchronous sampling and software-selectable gains (20mV maximum resolution). The analog pod replaces the standard 8-channel digital input pod to provide seven bits of resolution for analog data and one bit for digital data.

Circle (85) on Reply Card

## ESD protection kits

A series of static protection kits has been introduced by *Atrix*. The kits include one of four mat types, ground and wrist strap terminators, and color-coded alligator clip ground leads. Kits are customized according to the needs of the buyer.

Users may select from four mat types: conductive; 2-sided conductive/non-conductive; dissipative; and tri-layer (with a conductive layer in the center and dissipative layers top and bottom).

Circle (77) on Reply Card

## Backup power systems

*Panamax* has announced the PowerMAX line of backup power systems. When power failure occurs, the units' proprietary fast-transfer circuitry switches to the internal battery, typically within 2ms. The units use an internal battery to maintain power to computers and other connected components, providing power for up to 80 minutes (depending on the power demands of the connected system). Three versions are available: a 450VA unit with a 300W capacity; an 800VA unit with a 600W capacity; and a 1,200VA unit with a 1,000W capacity.

Circle (78) on Reply Card

## IC test clip

The model A-TEK IC test clip from *Davle Tech* is designed to facilitate temporary connections to the dual, in-line packaged components in conjunction with a number of test instruments for power on/hands off circuit testing. The test clips are available in 16-, 20-, 24- and 40-pin versions. Features include standard DIP spacing, gold-plated contacts, low-contact resistance and less than 1m $\Omega$  at 1kHz.

Circle (79) on Reply Card

## Wire analyzer

*SureTest*, developed by *Polytronics*, is a multi-function wire analyzer that detects problems common to electrical circuits. The portable, hand-held device tests for current-carrying capacity with a built-in, 15A load. The analyzer applies the load and determines if the voltage drop is less than 5%. The unit also checks circuits for voltage level, wiring connections and operation of a ground fault circuit interrupter.

Circle (80) on Reply Card

## Tack kit

The Micro Bond superadhesive tack kit from *Chemtronics* is designed for PC board rework and repair. The kit allows for wire tacking and component bonding to printed circuit boards, resulting in a low PCB profile that prevents damage due to sagging wires or loose components. The kit includes a 5-ounce bottle of #200 cyanoacrylate adhesive, an applicator needle and an activator pen. Each kit contains enough adhesive for about 800 to 1,000 drops.

Circle (81) on Reply Card

## Soldering iron/hot-air tool

*Weller* has introduced a cordless, pocket-size, lightweight tool that works as a soldering iron, a brazing torch or a hot-air tool. Fueled by butane gas, the unit is 7 inches long and fits into a shirt pocket. Temperature controls range

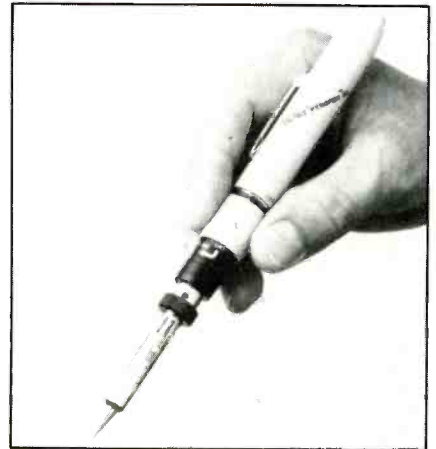

from 392°F to 842°F (200°C to 450°C) as a soldering iron; up to 806°F (430°C) as a hot air gun; and up to 2,372°F (1,300°C) as a torch.

Circle (82) on Reply Card

## Soldering station

The DPU30 electronic soldering station from *Oryx* is a 30W unit housed in a steel box designed for industrial production. It contains a connection for anti-static grounding and meets the requirements of DOD-STD-2000-1. Operating temperatures are adjustable between 465°F to 750°F, controllable to  $\pm 1\%$ . The station features a digital readout, solid-state power supply unit; 0V switching to ensure spike-free operation; and a proportional control circuit to eliminate temperature overshoot.

Circle (83) on Reply Card



# SPECIAL REPORT: Computer servicing

Welcome to our special report on computer servicing. Contrary to the fears of some of our readers, we do not plan to become another computer book. In response to a recent questionnaire in this magazine, more than 80% of those who responded said that they want to read articles about servicing televisions in *ES&T*. We have no plans to do anything other than continue heavy coverage of TV servicing for those readers, with at least one article on that subject in every issue.

On the other hand, the population of personal computers is growing, and a lot of you want to read about servicing them—nearly 50% of those who returned the questionnaire, in fact. That's the reason for this special report. (For more on what our readers' survey revealed, see the Editorial on page 4.)

Here's what the EIA had to say about personal computers in the 1987 issue of its publication, *Consumer Electronics Annual Review*:

"...many manufacturers feel that by the year 2000, consumers will be spending more for home information processing and communications equipment than they will for purely entertainment products.

"Functions normally associated with a business office are performed in nearly every home. Income and expenses have to be kept track of, appointments to be made and messages to be taken and delivered. There's correspondence to be handled and, where there are students in the house, reports to be researched and written. For many years businesses have turned to electronics for products that simplify and improve information handling. Now, similar, though much more affordable and often less complex products that bring office-like efficiencies to the home are being made and marketed by consumer electronics manufacturers.

"Almost 3.8 million personal computers were sold for home use last year and, with software and accessories, represented a \$3.8 billion business. Today a personal computer housed in a typewriter-like console, with brain power equal to that of the room-sized multi-million dollar computers of the 1960s,

can be purchased for less than \$300. Prices, however, can run up to \$2,000, depending on the functional capabilities, memory power and accessories included.

"The term 'computer literate' has become more than a catch phrase to describe those in the know. It's now a requirement for graduation from many high schools and colleges, and some colleges include the cost of a computer for each student in their tuition. 'Keyboarding,' or how to interact with a computer, is being taught at the elementary grade level.

"In the home, computers are used for financial and family function planning, record keeping, educational enrichment, training and word processing. Connected to the telephone lines through a built-in or add-on device known as a modem, computers provide access to outside data banks containing a vast variety of research information, along with business, professional and transportation directories, games and message centers that serve as electronic bulletin boards for computer owners with similar interests. Modems also let computers be used for home shopping, banking and travel reservation services that are now becoming available."

This special report is intended to bring together several types of important information on computer servicing, in particular:

- a concise overview of the development of personal computers and approaches to servicing;
- some specific problems and cures for the Apple II+ personal computer;
- specific suggestions on servicing the Commodore disk drive;
- a comparison and contrast between active and passive breakout boxes, describing the advantages and drawbacks of each; and
- a discussion of how to use a logic probe in computer servicing.

The usefulness and ease of use of personal computers is increasing rapidly; at the same time, the cost is coming down precipitously. Their numbers will continue to grow, and many of those computers will need servicing at some time in their lives. We hope you benefit from this special report.

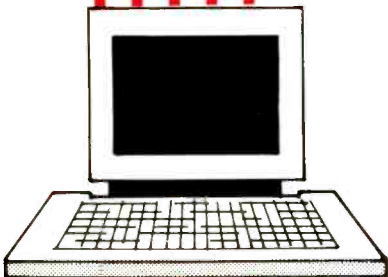

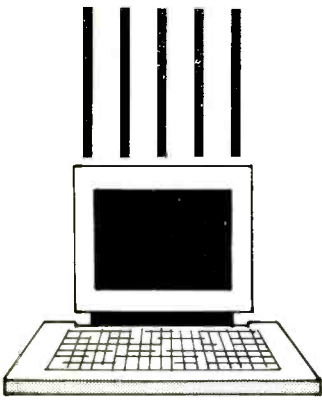

# Troubleshooting microprocessor-based circuits

## Part I: The world went digital

By Tom Allen

*This is Part I of a 2-part article exploring the changes in electronics troubleshooting brought about by the growing popularity of microprocessor-based products. In this first segment, we'll discuss how analog, digital and microprocessor-based systems differ; why traditional troubleshooting equipment isn't sufficient for microprocessor-based products; and what new types of equipment have emerged to fill the gap. Next month, we'll explore the techniques needed to troubleshoot microprocessor-based systems effectively and show how these techniques, together with an inexpensive digital tester, can significantly simplify the process of troubleshooting microprocessor-based products.*

The past 25 years have witnessed a technology explosion that has completely changed the nature of consumer electronics, causing the familiar analog circuitry of the past to be replaced first with digital and then with microprocessor-based circuits. Although the new microprocessor-based systems may have simplified the lives of consumers, they have made the job of the service technician a great deal more complicated than in the past.

Take the case of a simple wall thermostat, for example. Once thermostats consisted simply of a bimetal bar and a pair of contacts. Now they have liquid crystal displays and keypads. Today's automobiles make heavy use of microsystems for purposes ranging from emission control to mileage and gas calculation. Even the cash registers at the supermarket checkout line are heavily computerized.

Allen is product specialist, Service Equipment Group, at John Fluke Manufacturing Company, Everett, WA.

Two key events played a key role in creating this technology explosion. The first, the development of the integrated circuit (IC), sparked the move from analog to digital circuitry. The second, the development of the microprocessor, opened the door for microprocessor-based electronics.

### Analog to digital circuitry

The appearance of the first ICs in the early 1960s was a direct result of the efforts that were then being made to put a man on the moon. Computer technology was a necessity if the expedition was to succeed, but computers were far too large at that time to fit inside a space capsule. It was this need for smaller computers that led to the development of the first IC.

As the price of ICs decreased, they began to appear in other applications, including a variety of consumer electronics products. Digital circuitry began to replace analog circuitry in products ranging from clocks and watches to microwave ovens and TV tuning systems. Without ICs, this transition from analog to digital circuitry simply would not have been possible: The digital electronics would have taken up far too much space to be practical.

### Digital to microprocessor-based circuits

In 1974, Intel Corporation developed the world's first microprocessor, the 4004. Use of the technology originally was limited to military and industrial applications, such as instrumentation, communications equipment and data processing equipment. As with ICs, however, continued development of the technology, together with significant price reductions, soon led to the increas-

ing appearance of microprocessor-based circuitry in consumer electronics products. Figure 1 demonstrates this growing trend, showing how the number of microprocessor-based boards in production has increased from 1980 to 1985.

### Microprocessors vs. microcontrollers

It should be noted that the term *microprocessor* may be used in both a generic and a specific sense. In a generic sense, a microprocessor is any chip-sized device capable of making decisions and sending out instructions based on values entered into it. In a more technical sense, however, the term microprocessor refers only to those chip-sized computing devices that do not contain their own built-in control program. Instead, the microprocessor's control program is built into a separate chip known

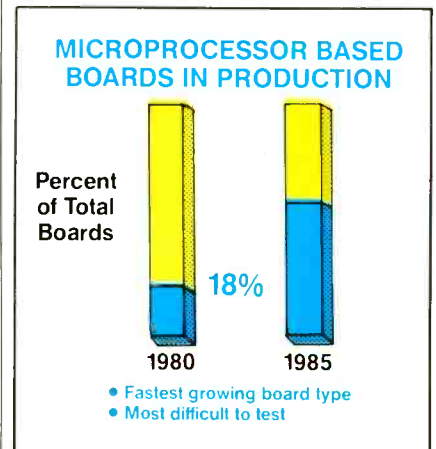

**Figure 1.** The increase in the number of microprocessor-based products being manufactured is reflected in the growth of the number of microprocessor-based printed-circuit boards as a percent of total circuit boards in production. As shown here, between 1980 and 1985 microprocessor-based boards as a percentage of all circuit boards in production increased from 18% to 65%.



as read-only memory (ROM). Microprocessors also make use of another chip, known as random-access memory (RAM), as a temporary holding area for data. Personal computers are a good example of a system based on a true microprocessor.

Less sophisticated microsystems, in contrast, have a built-in control program and little, if any, RAM. Technically speaking, these microsystems are based on microcontrollers, not microprocessors. Microcontrollers are typically found in products such as microwave ovens, VCRs and CD players.

In this article, we will be focusing on microsystems based on true microprocessors, not microcontrollers, although the two share many of the same characteristics.

### How the circuitry differs

There are certain elements that are common to all types of circuitry, such as the presence of some type of power supply (even if only a battery) and some type of human interface for control purposes, display purposes or both. Beyond these few elements of commonality, however, the three types of circuitry are characterized more by differences than by similarities. The key differences among the three types of circuits are outlined below.

**Analog circuitry:** The primary characteristic of analog circuitry is that it provides an infinite number of values between 0 and the specified ceiling level of a signal. Consequently, analog circuitry uses control and display devices such as volume knobs and clock dials, which move in continuous increments rather than in discrete steps. The continuous nature of these control and display devices, however, makes analog signals highly susceptible to distortion. That is, even slight distortions in reading or controlling a signal's amplitude can result in distorted information, because

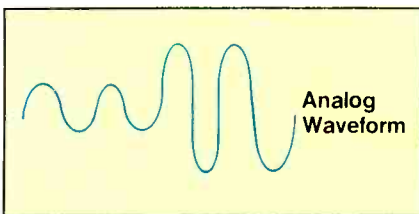

**Figure 2.** Analog waveforms are usually continuous, as typified by the smooth curve shown here. They do not change abruptly from one value to another. They are, however, susceptible to distortion.

the exact amplitude of the signal is significant in interpreting its value. Similarly, the polarity of an analog signal conveys significant information.

Analog signals may be either static, as is the case with bias levels on an amplifier, or dynamic, as is the case with a local oscillator in a stereo system or a color-burst oscillator in a television. However, the dynamic signals always change in a repeatable manner, making them relatively easy to measure during troubleshooting. Figure 2 shows an example of a typical analog waveform.

**Digital circuitry:** Unlike the continuously variable values found in analog circuitry, digital circuitry is based on discrete values. These values are developed using a binary numerical system in which a signal can have only one or two values—on or off (represented as 1 and 0). Figure 3 shows a typical digital waveform.

In digital circuitry, a signal of +3.5Vdc or higher is typically considered to be *on*, and one of +0.7Vdc or lower is considered to be *off*. Because the voltage level indicates only whether the signal is on or off, as opposed to its exact value, small changes in voltage will not affect the accuracy of the information being conveyed by the signal. Similarly, the polarity of the signal is not significant in interpreting its meaning: It is simply there (on) or not there (off).

As with analog circuitry, digital signals may be static or dynamic and those that are dynamic are generally repeatable. For example, the signal generated by pressing a key on a thermostat or microwave is dynamic in that it is there only when you press the key. But it is repeatable in that the same logic level is generated each time you press the key. Therefore, digital and analog signals are both relatively easy to measure with traditional test equipment.

A final characteristic of digital cir-

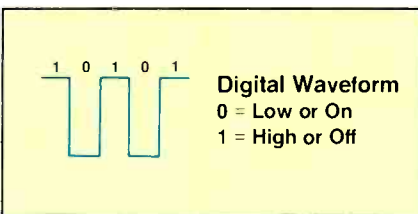

**Figure 3.** Digital information is coded in terms of values that assume one of two distinctly different values. Digital waveforms are, therefore, characterized by abrupt changes from one value to another, as shown here.

cuitry is that it contains one or more digital logic devices. On the low end, these may be as simple as a few AND and OR gates, as shown in Figure 4. On the high end, the circuit may include programmable logic devices (PLDs) or other application-specific ICs (ASICs). Digital circuits may also include analog-to-digital converters to convert analog values, such as temperature, into digital representation.

**Microprocessor-based circuitry:** Microprocessor-based circuits are significantly more complex than either analog or digital circuits. Like digital circuits, they are based on a binary numerical system, in which a signal is either on or off. However, they go beyond digital circuits in that the microprocessor is more than just an IC: It is a tiny computer. Under the control of a program, it can accept user-entered data and then make decisions and take actions based on that data.

Because the operations performed by a microprocessor are determined by software instructions rather than being built into the circuitry, you can change the function of a circuit without rewiring it. All you need to do is switch to a different set of software instructions. These instructions may be stored in some form of programmable storage medium, such as a floppy or hard disk, or they may be built into the unit's ROM (in which case they are technically known as *firmware*). In the latter case, you would need to replace the existing ROM chip with a new one, but this is still much easier than designing and rewiring the entire circuit.

Like analog and digital systems, microprocessor-based systems contain a power supply of some sort and a human interface of some sort. In addition to these elements shared with all circuitry, however, microprocessor-based systems contain several components that are unique to this type of circuitry alone.

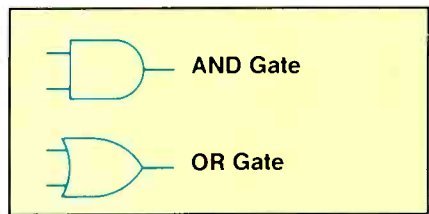

**Figure 4.** Two of the basic building blocks of digital circuits are the AND gate and the OR gate. These circuit segments will be found in digital circuits from the simplest to the most complex.

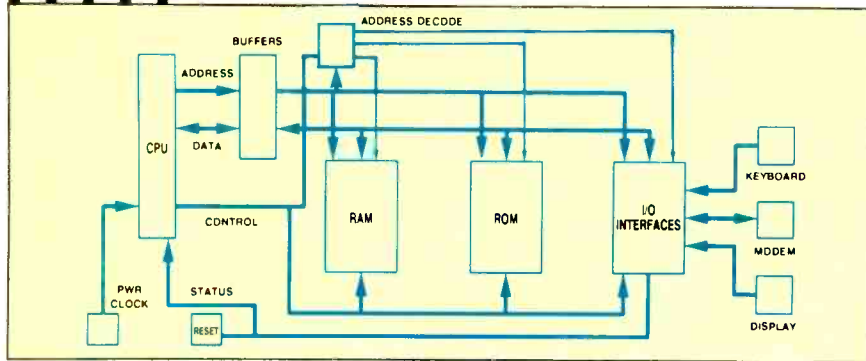

**Figure 5.** A typical microprocessor-based system contains the functional blocks shown in this illustration. See the text for a brief description of each of the blocks.

These components include the microprocessor itself, ROM, RAM, an input/output (I/O) interface, buffers, buses (signal lines) of various sorts, address decoders and a clock. Some microprocessor-based systems also include a DMA (direct memory access) controller. Each of these components is illustrated in Figure 5 and described in the sidebar.

### How troubleshooting equipment has evolved

As electronics products have evolved from analog to digital to microprocessor-based systems, the equipment required to troubleshoot these products has gone through a corresponding evolution. The traditional multimeters and oscilloscopes are still useful, but they are no longer sufficient to do the job: The complexity of microprocessor-based systems requires the use of newer, more sophisticated tools. For evidence of the difficulty of isolating faults on microprocessor-based boards using traditional test equipment, look at the repair statistics: Some 40% to 60% of the microprocessor-based boards sent back for repair are found to have no defects. Their operation simply couldn't be verified properly using traditional test equipment.

In this section we'll take a look at the evolution of test instrumentation, explaining the benefits and limitations of five types of instruments: multimeters, oscilloscopes, logic analyzers, signature analyzers and emulative testers.

**Multimeters:** Multimeters, capable of measuring voltage, current and resistance, traditionally have been one of the most useful tools for electronics troubleshooting. Although the original multimeters were analog devices, most service technicians today use digital multimeters, which are more rugged and more accurate than their analog counterparts.

Multimeters work best for measuring static signals—those signals that don't change over time. However, there are few such signals in microprocessor-based circuitry. Multimeters can be used for such purposes as determining whether the power supply is putting out the proper voltage or whether a particular bus is shorted to ground. But most

# Stop Board Float

## For Personal Computer Maintenance

- Automatic Intelligent Diagnostics using 8088  $\mu$ P
- Tests complete system board in 60 seconds
- Menu-driven color graphics display provides Guided Fault Isolation
- User friendly - Product specialist not required
- Eliminates "board float"

AID/88 PC Test System provides high-speed trouble-shooting of PC system boards and adapter cards to the component level.

Fast repair saves you time and money. Why incur costly "board float" and repair delays when an entry-level technician can diagnose a board problem within 60 seconds and replace the faulty component on



AID/88 PC Test System

the spot? Stop wasting time and money - let AID/88 show you the sensible way to keep PCs up and running with tremendous savings in time and money. Call today!

Convenient lease plan available.



9180 Brown Deer Road  
San Diego, CA 92121  
(619) 452-7670

Why replace the board  
when a chip is all you need?

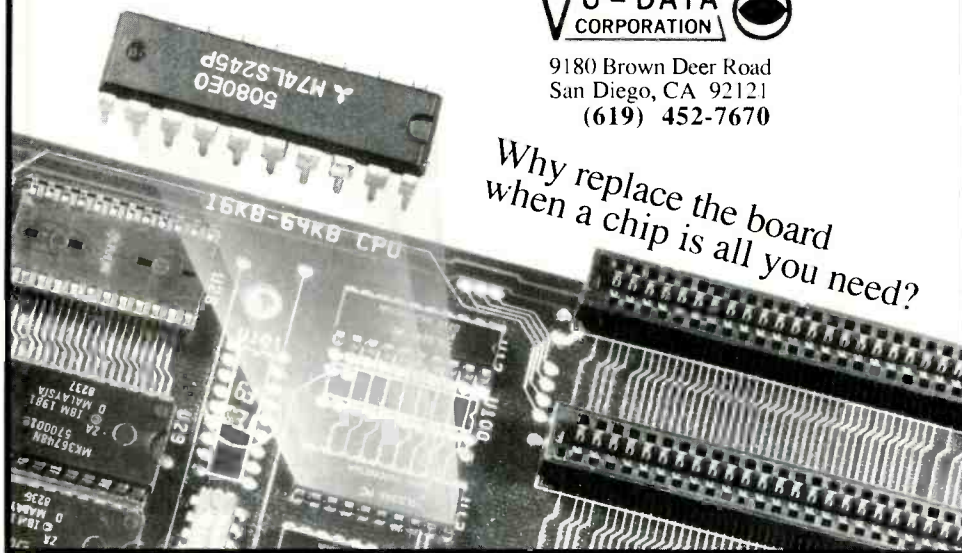

Circle (9) on Reply Card



microprocessor signals are dynamic, changing millions of times per second as data is moved on and off the bus. Because a multimeter has no way of measuring time, it can't be synchronized to the microprocessor clock. Therefore, it has limited usefulness in a microprocessor-based environment.

**Oscilloscopes:** The oscilloscope—the other traditional tool of the service technician—is better than the multimeter for measuring dynamic signals because its trigger mechanism allows the technician to select a particular time window for measuring a signal. However, it works best for those dynamic signals that are repeated in a predictable manner, and microprocessor signals tend to be non-repetitive. This characteristic, together with the high speed of microprocessor signals, makes them hard to capture on an oscilloscope. The result may be a jittery display, with multiple signals appearing superimposed on one another as in a double-exposed photograph. Using a high-frequency digital storage oscilloscope will alleviate this problem, but such instruments may be too expensive for a service operation to afford.

Another drawback: Oscilloscopes can display measurements for only one or two bus lines at a time. In microprocessor-based systems, the timing relationships between events on different lines is important, so the usefulness of oscilloscopes for microsystem troubleshooting is limited.

A third problem is that the oscilloscope's measurements may be difficult to interpret. To know what its findings mean, a technician needs a detailed knowledge of the circuitry of the unit under test. This fact alone makes the oscilloscope an impractical solution for shops that handle a variety of microprocessor-based boards.

**Logic analyzers:** Logic analyzers are more sophisticated than oscilloscopes because they can display data streams for several lines at a time, allowing the technician to examine all data lines—even all data and address lines—simultaneously. However, there are several drawbacks to using logic analyzers for microsystem troubleshooting. First, their high price may put them outside the reach of many service operations. Second, they take a long time to set up, making them expensive to operate. Finally, like oscilloscopes, they provide no

help in interpreting the results, so the technician must have a detailed knowledge of the circuitry of the unit under test to understand what the measurements mean. All of these characteristics make the logic analyzer more useful in a design environment than in a service operation.

**Signature analyzers:** Signature analyzers are used in conjunction with a special diagnostic program located in

the board's ROM. The program stimulates the board, causing a data stream to appear at different points in the circuitry (nodes). The signature analyzer then interprets this data stream as output by particular ICs on the board, timing this interpretation to occur between a specified START and STOP signal. The interpretation step involves a special algorithm that translates the data stream into an abbreviated code, or *signature*.

(Continued after sidebar.)

**CALL TOLL FREE**

Include work address and phone number for Free Catalog.

**800-824-2873**

**DIGITAL MULTIMETERS**

**BECKMAN**

*Beckman Industrial!*

- All 300, HD, and Circuitmate series
- All accessories in stock

MODEL	PRICE
HD100	\$169
HD110	\$199
HD130	\$259
HD140	\$279
300	\$179
310	\$145
320	\$179
330	\$219
350	\$229
360	\$289
4410	\$239

**FLUKE** 

- Autorange  Analog display
- Touchhold function
- 0.3% accuracy  Heavy duty

MODEL	PRICE	MODEL	PRICE
21	\$ 99	75	\$109
23	\$145	77	\$145
25	\$229	8010A	\$289
27	\$259	8012A	\$359
37	\$215	8020B	\$199
52	\$189	8024B	\$249
73	\$ 79	8050A	\$399

FLUKE 77  Digital Multimeter

**SALE \$119**

LIST \$145

**WAYNE KERR**

MODEL	PRICE
4210	\$2200
4225	\$1500

**SCOPES**

**HITACHI**



Denshi America, Ltd.

- All 20 models in stock
- 2-3 year warranties
- 20-100 MHz

MODEL	PRICE
VC6041	\$3900
V209	\$798
V222	\$575
1050	\$1299
1100A	\$2490
422	\$740
425	\$845
680	\$1275

**HITACHI V-509**

Portable Dual Trace Scope

**SALE \$1199**

LIST \$1445

**IWATSU**



- All 14 models in stock
- 2-3 year warranties
- 20-250 MHz

**IWATSU (CONT.)**

MODEL	PRICE
5702	\$ 535
5705	\$ 899
5706	\$ 749
5710	\$1245
5711	\$1695
5712	\$2999

**POWER SOURCES**

**POWER DESIGNS**

- Low and high voltage power sources
- 1-5 year warranties

MODEL	PRICE
TP340	\$750
TP343A	\$795
TW347	\$590
TW5005W	\$505
TW6050A	\$748
2K20	\$695
2020B	\$750
4050	\$560
6150	\$615

**SOLA POWER**

MODEL	PRICE
SPS800	\$ 873
63-13-114	\$ 237
63-13-150	\$ 456
63-13-175	\$ 580
63-13-210	\$ 672
750VAUPS	\$1976
750VAUPS1	\$2580

**USED TEST EQUIPMENT, TOO!—OVER 3,000 MODELS AVAILABLE AT HUGE DISCOUNTS WITH WARRANTIES!**

■ Quantity Discounts Available ■ Dealers Welcome ■ Freight and Tax Extra ■ Immediate Availability of Equipment

**US United States Instrument Rentals, Inc.**

A U.S. Leasing Company  
2988 Campus Drive  
San Mateo, CA 94403

Circle (10) on Reply Card

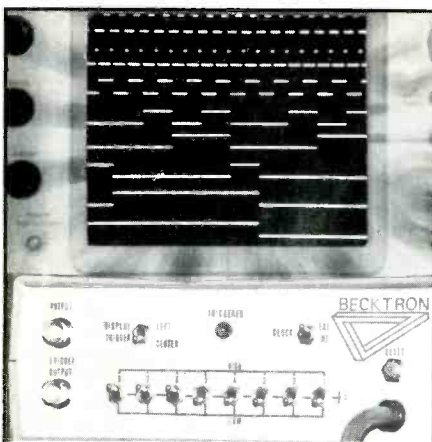

## At Last A-96 LOGIC ANALYZER

8 Channels of  
Logic Signals

\*\*\*

2 thousand  
Samples Per Channel

\*\*\*

Up to 16  
Thousand Timing  
Events Displayed

\*\*\*

Pre-trigger and  
Post-trigger Data  
Capture

\*\*\*

Internal or External  
Clock Data  
Capture

\*\*\*

and many more  
features at an  
affordable price

**\$569.00**

for more details contact

**BECKTRON**  
Honing The Technical Edge

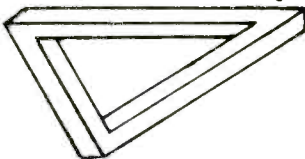

today, at **1-800-592-4141**  
or your local distributor

Circle (11) on Reply Card

## Components of microprocessor-based systems

**Microprocessor:** The "brains" of a microprocessor-based circuit reside in the microprocessor itself. That is, everything that happens in the circuit is initiated by the microprocessor. Although the microprocessor is a tiny computer, it is really not that complicated a device. It can do only one thing at a time, and then only under the direction of the control program. And the operations it performs consist primarily of data reads, data writes and basic arithmetic operations. In other words, in response to instructions contained in the control program, the microprocessor orders data to be placed on the databus, reads it, performs arithmetic operations on it as required and writes (sends) the resulting data out to specific circuit elements over the same bus. Even the most complex program instructions can be reduced to these few simple operations.

**ROM:** The ROM contains built-in instructions for the microprocessor. These instructions are specific to a particular type of microprocessor and are known as its *instruction set*. Of course, many types of microprocessor-based systems, such as personal computers, obtain additional instructions through software programs. But all microprocessor-based systems need ROM instructions to get them started when the system is first powered up to tell them what to do and where to find the data they need. Without these ROM instructions, they would be unable to load and read other software instructions. In effect, the ROM instructions allow the system to pull itself up by its bootstraps, which is why the process of turning a computer on is known as *booting*.

**RAM:** RAM consists of one or more integrated circuit memories. It serves as a temporary storage area for data, holding it where it will be readily accessible when needed. There are two key differences between RAM and ROM:

- RAM can be written to and read from, whereas ROM can only be read;
- RAM serves only as a temporary data storage area, whereas ROM stores data permanently. This means that data can be moved in and out of RAM as needed. It also means that once the power is turned off, all the data in RAM is lost.

In effect, RAM serves as scratch pad for the microprocessor, keeping data handy while it is needed and replacing it with

new data when a new operation is begun.

**Input/output interface:** The I/O interface allows the microprocessor "kernel" (consisting of the microprocessor itself, ROM, RAM, buses, address decoders and clock) to communicate with the system's input/output devices (keyboard, video display and printer). These I/O devices are also known as *peripherals*, because they lie outside the microprocessor kernel.

Unlike the components of the microprocessor kernel, I/O devices are not always governed by the microprocessor clock. This is why the peripheral portions of a microprocessor-based system are often said to be *asynchronous*—their timing is not synchronized to the microprocessor clock.

**Buffers:** The I/O section of the circuitry typically includes various buffers that serve as temporary holding points for data on its way to or from the kernel. For data going to the kernel (i.e., input), these buffers hold the data until the microprocessor is ready to read it. For data that the microprocessor is sending to a peripheral device (i.e., output), the buffers hold the data until the device is ready to receive it.

**Buses:** Buses are communication paths: They conduct information from one place to another. A microprocessor-based system has three types of buses:

- **Databus:** The databus carries information to and from the microprocessor, connecting it with every part of the system that handles data: RAM, ROM, I/O devices and, if present, DMA controller and mass storage (floppy or hard disk). The number of databus lines in a system is equal to the number of bits its microprocessor can handle at a time, because each bit requires its own line. Thus, an 8-bit microprocessor needs eight databus lines; a 16-bit microprocessor needs 16.
- **Address bus:** The address bus carries information about where a particular piece of data is to be found or sent. Each device in the system (ROM, RAM, I/O, etc.) has a specific range of addresses unique to that device. The data and address buses work together to respond to the microprocessor's read and write requests—one specifying the data origin (or destination), the other providing a path on which the data can travel.
- **Control and status bus:** The microproc-



# SELECT 5 BOOKS for only \$3.95

(values to \$127.70)  
and get a Free Gift!

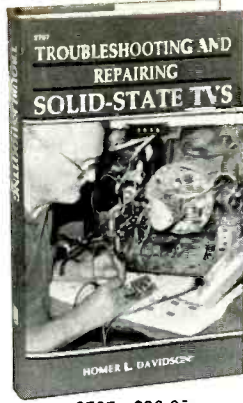
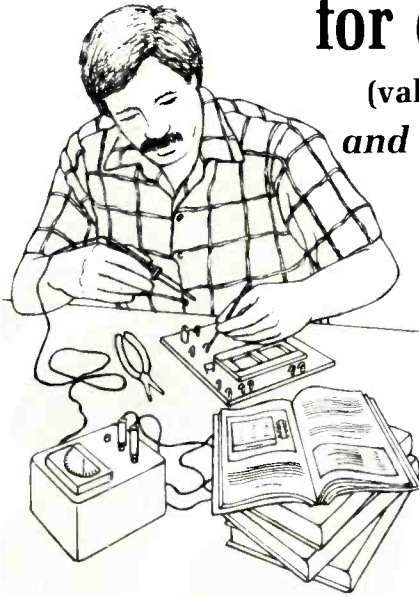

2707 \$26.95  
Counts as 2

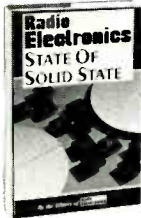

2733 \$14.95

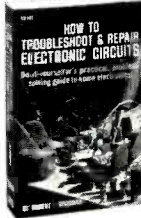

1218P \$14.95



1599P \$16.95

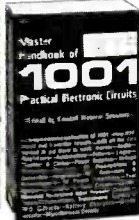

800P \$19.95



2781 \$18.95

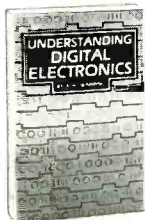

1593P \$8.95

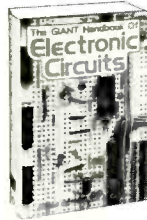

1300P \$24.95

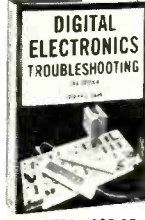

2750 \$25.95  
Counts as 2



1498P \$11.95



2832 \$23.95

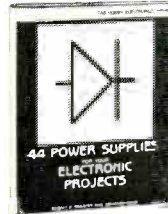

2922 \$24.95



663P \$17.95

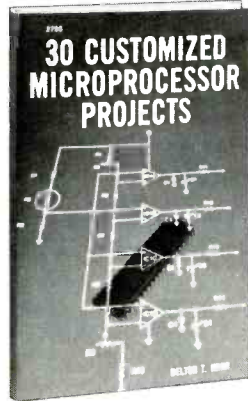

2705H \$22.95



1199P \$16.95

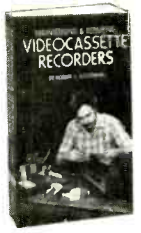

1503P \$15.95



2635 \$19.95



2936 \$14.95



2660P \$17.95



1586 \$17.95

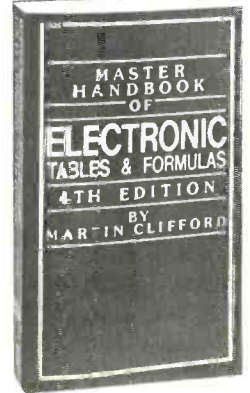

1625P \$14.95



1160P \$10.95



1583P \$13.50

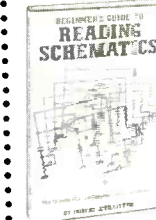

1536P \$8.95

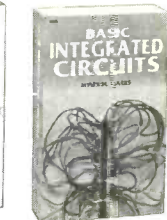

2609P \$16.95



2795 \$24.95  
Counts as 2



2800 \$23.95

Electronics projects . . . ideas . . . the latest technology  
all at up to 50% off publishers' prices

**Membership Benefits • Big Savings.** In addition to this introductory offer, you keep saving substantially with members' prices of up to 50% off the publishers' prices. • **Bonus Books.** Starting immediately, you will be eligible for our Bonus Book Plan, with savings of up to 80% off publishers' prices. • **Club News Bulletins.** 14 times per year you will receive the Book Club News, describing all the current selections—mains, alternates, extras—plus bonus offers and special sales, with hundreds of titles to choose from. • **Automatic Order.** If you want the Main Selection, do nothing and it will be sent to you automatically. If you prefer another selection, or no books at all, simply indicate your choice on the reply form provided. As a member, you agree to purchase at least 3 books within the next 12 months and may resign at any time thereafter. • **Ironclad No-Risk Guarantee.** If not satisfied with your books, return them within 10 days without obligation! • **Exceptional Quality.** All books are quality publishers' editions especially selected by our Editorial Board. (Publishers' Prices Shown)

## FREE when you join!

Reference Guide to Electronics  
Manufacturers' Publications  
A time- and money-saving list  
of product literature from all  
the major electronics suppliers.  
(a \$6.95 value)

Reference Guide  
to Electronics  
Manufacturers'  
Publications



## ELECTRONICS BOOK CLUB

Blue Ridge Summit, PA 17294-0810

Please accept my membership in the Electronics Book Club\* and send the 5 volumes listed below, plus my FREE copy of Reference Guide to Electronics Manufacturers' Publications (2683P), billing me \$3.95 plus shipping and handling charges. If not satisfied, I may return the books within ten days without obligation and have my membership canceled. I agree to purchase at least 3 books at regular Club prices (plus shipping/handling) during the next 12 months, and may resign any time thereafter.

Name \_\_\_\_\_  
Address \_\_\_\_\_  
City \_\_\_\_\_  
State/Zip \_\_\_\_\_ Phone \_\_\_\_\_

Valid for new members only. Foreign applicants will receive special ordering instructions. Canada must remit in U.S. currency. This order subject to acceptance by the Electronics Book Club\*  
All books are hardcover unless numbers are followed by a 'P' for paperback. EST-188

Circle (12) on Reply Card

essor is also connected to the other kernel devices with control and status lines. These lines allow the microprocessor to specify whether it wants to read data from a particular device or write data to it. They also provide a means for the device to notify the microprocessor when it has data for it. Thus, when the RAM chip, for example, sees that READ is enabled on the control/status line, it takes the data that is stored at the address currently on the address bus, places it on the databus and notifies the microprocessor that the data it wants is on the bus. When the RAM chip sees that WRITE is enabled, in contrast, it copies the data pattern that is on the databus and stores it at the address specified on the address bus.

Both the databus and the address bus typically have buffers located at the outer boundary of the kernel. These isolate the buses from other circuits on the board, protecting them from effects such as noise or loading.

**Address decoders:** Address decoders on the address bus notify each device (RAM, ROM, etc.) when the address placed on the bus by the microprocessor

is within the address range of that particular device. This notification is performed by turning the device's chip select (CS) pin on or off. Because a device can respond to a microprocessor request only when its CS pin is on, this approach prevents the wrong device from responding.

**Clock:** The rate at which the microprocessor executes instructions is determined by the system clock, which sends pulses to the microprocessor millions of times per second. (In a system running at 8MHz, for example, the clock is emitting 8 million pulses per second.) All data movement within the kernel is synchronized to these pulses. A key function of the clock is to make sure that data placed on the bus has time to stabilize before a read or write operation takes place. That is, the clock's pulses define the valid "window" or time period for data reads and writes.

**DMA controller:** Some microprocessor-based systems also have a device known as a DMA (direct memory access) controller, which can move data to and from

memory without going through the microprocessor. As a device whose sole function is to perform data transfers, the DMA controller can move more data in less time than the microprocessor, which also has internal operations to perform. Consequently, it is typically used for data transfers involving high-speed devices, such as hard disks.

Like the other devices in the system, the DMA controller operates only in response to instructions from the microprocessor. However, to perform its work, it needs to "borrow" the data, address and control lines from the microprocessor. The process by which this is done is known as *cycle stealing*. For one or more clock pulses (cycles), the DMA chip takes over the databuses and the microprocessor restricts itself to internal work (such as performing arithmetic operations on the data already in its registers). Because the microprocessor won't let go of the buses for more than a few cycles at a time, however, the DMA controller and microprocessor may pass control of the buses back and forth several times before the DMA controller completes a task.

In a properly functioning microsystem, a given node will always produce the same signature in response to the same stimulus when measured within a particular time window. Therefore, by comparing the actual signature of a node with the correct signature for that node, the technician can determine whether the output at a particular node is good or bad. Once a node is found to have a faulty signature, the technician traces back through the circuitry from that point looking for a device that has bad output but good input (one where the signature of the preceding device was correct). This device is likely to be the source of the fault.

Signature analysis is well-suited to troubleshooting microprocessor-based systems: It is fast, it allows the measurement to be timed to particular events, and it simplifies interpretation of the results. The technician does not need detailed knowledge of a specific board's circuitry. Whether a node is good or faulty can be determined by simply comparing its signature to that of the same node on a known-good board.

However, signature analysis does have its limitations. First, it can be used only on boards that were designed specifically for this technique—boards for

which the manufacturer has included a special diagnostics program in the unit's ROM and specified the required START and STOP signals. Also, the manufacturer must provide the correct signature for each node, or the technician must collect these signatures from a known-good board. Finally, because actual signature of a node is created by an algorithm specific to the signature analyzer, the technician's signature analyzer must be compatible with the one used by the manufacturer or the signature won't match.

**Emulative testers:** One of the most effective instruments for troubleshooting microprocessor-based systems is the emulative tester, because this type of instrument tests the board from the inside out. The tester copies, or *emulates*, the functions of one of the kernel devices that is capable of reading and writing data to other devices on the board. By sending out a known stimulus to each device and measuring its response, the emulative tester is able to verify that each device in the kernel is operating properly.

There are three types of emulative testers: microprocessor emulators, ROM emulators and the recently intro-

duced DMA emulators. All three types are quick and easy to set up, because they connect to the board at a single point. All are well-suited to measuring the dynamic, nonrepetitive signals that characterize microprocessor-based circuitry, because they are capable of synchronizing their measurements to the cycle of the microprocessor clock. (Some also include a logic probe that can be synchronized to events other than the microprocessor clock, allowing them to be used to measure events that occur more intermittently.) Finally, all three are easy to use because they perform many of their tests automatically. Also, emulative testers provide the technician with an interpretation of the test results, making them ideal for those who do not have a detailed knowledge of a specific board's circuitry.

• **Microprocessor emulators:** Microprocessor emulators either clip over the microprocessor or plug into its socket. Like the microprocessor itself, microprocessor emulators can read and write data to any addressable device or memory location, allowing the technician to thoroughly exercise every node on the board. Because they replace the board's microprocessor with their own, they are effective even when one or more of the



kernel components is completely dead.

Because each type of microprocessor has its own characteristics, a microprocessor emulator needs some way of being tailored to the characteristics of the particular microprocessor it is emulating. This is achieved through special hardware modules, called pods, which contain microprocessor-specific information.

- ROM emulators: ROM emulators plug into the ROM socket, taking control of the board by replacing the ROM control program with diagnostic software that exercises all parts of the board. They are more limited than microprocessor emulators because they can only be used on boards that have a properly functioning microprocessor and ROM address decoder as well as no stuck or shorted bus lines. They are also limited to testing systems that have a removable control program—that is, systems where the control program is located in a separate and unsoldered ROM rather than in the processor itself. Because of this limitation, they can be used only to troubleshoot true microprocessor-based systems as opposed to systems that are

based on microcontrollers.

ROM emulators have the advantage of not requiring a specific hardware interface unit for each type of microprocessor, because they use the board's own microprocessor to perform the data reads and writes. They do, however, require a software interface for each type of microprocessor to be able to communicate with it during data reads and writes.

- DMA emulators: DMA emulators clip over the board's microprocessor. Like the DMA controller they emulate, these test instruments steal cycles from the microprocessor and use them to read and write to memory directly.

DMA emulators are similar to microprocessor emulators in that they do not require the kernel to be fault-free in order to conduct full sets of tests. They are unlike both microprocessor and ROM emulators, however, in that they do not take complete control of the unit under test. Instead, they take their measurements while the board is operating in its normal environment. This approach makes them useful for testing boards that exhibit problems when run-

ning their own control software. These emulators are also ideal for testing boards with solder-in components because they do not require removal of either the microprocessor or the ROM chip.

As the preceding discussion has shown, microprocessor-based systems are much more complex than traditional analog, or even digital, circuitry. Therefore, attempting to troubleshoot such systems using only the traditional tools of the service technician, such as multimeters and oscilloscopes, is time-consuming and difficult. This type of troubleshooting also requires a detailed knowledge of the circuitry of the unit under test, because traditional instruments provide no assistance with interpreting the results of the measurements they take.

Part two of this series will take a closer look at how this new type of equipment works, explaining the general approach for troubleshooting microprocessor-based systems and walking the reader through a specific troubleshooting example.

**ES&T**

# NEW RUGGEDIZED SCOPE PROBES

Just a phone call away.

**\$35** P6103

50 MHz 10x  
Compensation Range  
15 to 35 pF

**\$58** P6109

150 MHz 10x  
Compensation Range  
18 to 22 pF

These new passive voltage probes can be used with any oscilloscopes having matching compensation ranges.

Screw in tips mean easy repair, no downtime.

To order call toll free **1-800-426-2200**

In Oregon, call collect (503) 627-9000.

VISA and MasterCharge accepted.

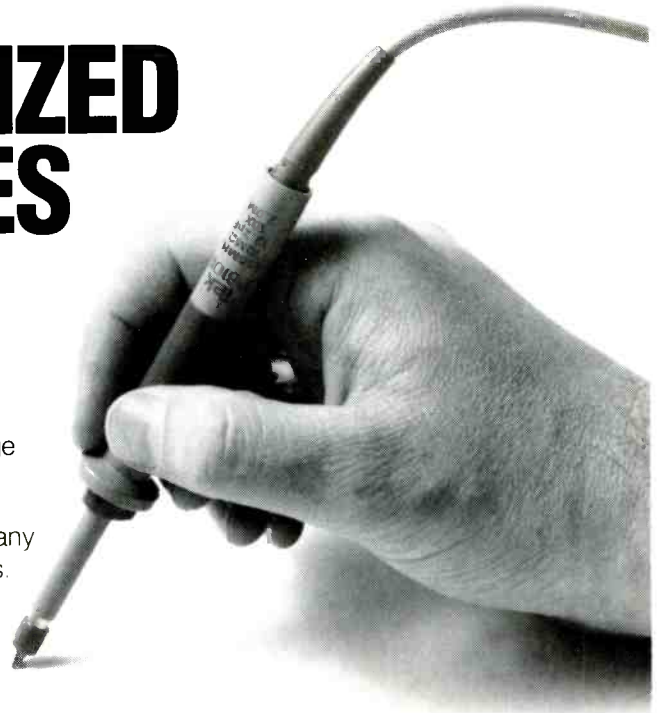

**Tektronix**  
COMMITTED TO EXCELLENCE

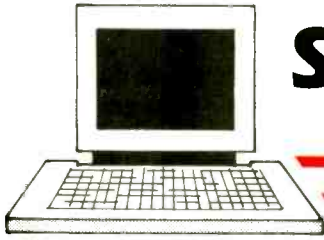

# Servicing the Apple II+ computer

By Michael J. Zoiss, CET

The Apple II is a great tool for learning the basics of computer hardware and digital troubleshooting because it is a basic, single-board microcomputer. (See Figure 1.) Digital troubleshooting requires the same steps necessary to repair anything electronic: Understand how the equipment operates, then analyze the symptoms. This information will help lead you right to the problem. The following five case histories of servicing

the Apple II computer demonstrate how to apply these principles.



*Symptom: No response when the computer is turned on.*

*Clue: Different sound to the high-frequency power supply when turned off.*

In this case, there was no video, the disk drive wouldn't boot, and the power

light was off. One other symptom, which gave a clue to the problem, was that the high-frequency switching power supply sounded different when the computer was turned off.

In this case, the symptoms suggest that the first item to check is the power supply. But let's look at the evidence first. The power-on lamp is driven by a +5V supply. Because the lamp isn't lit, we know the +5V is gone. Also, because an unusual, high-pitched squeal was heard when the power supply was turned off, the power supply is probably good. The problem was most likely a power-supply overload on the +5V supply revealed a direct short to ground.

A direct short in any of the supplies is most likely a shorted 0.1 $\mu$ F decoupling capacitor. The question is, which capacitor out of approximately 45 is it? The only safe way to find the offending capacitor is to keep an ohmmeter connected across the +5V supply with the Apple power supply disconnected and desolder one leg of each capacitor until the meter reading indicates an open. Because this board is double-sided, I suggest the only way to desolder the component leads is to use a vacuum desoldering station. Any other method can damage the printed circuitry or the components.

As Murphy's Law would have it, every decoupling capacitor for the +5V supply was checked and the B+ short remained. However, the test wasn't entirely inconclusive. If the short wasn't caused by a decoupling capacitor, then there must have been another reason for the B+ short. Close examination of the expansion edge card connectors revealed a tiny piece of metal lodged between pins 25 and 26 (+5V and ground, respectively) of slot 5. Removing it restored proper operation.

Zoiss is owner and operator of Circuit Masters, Indianapolis, IN, a small electronics design and repair company.

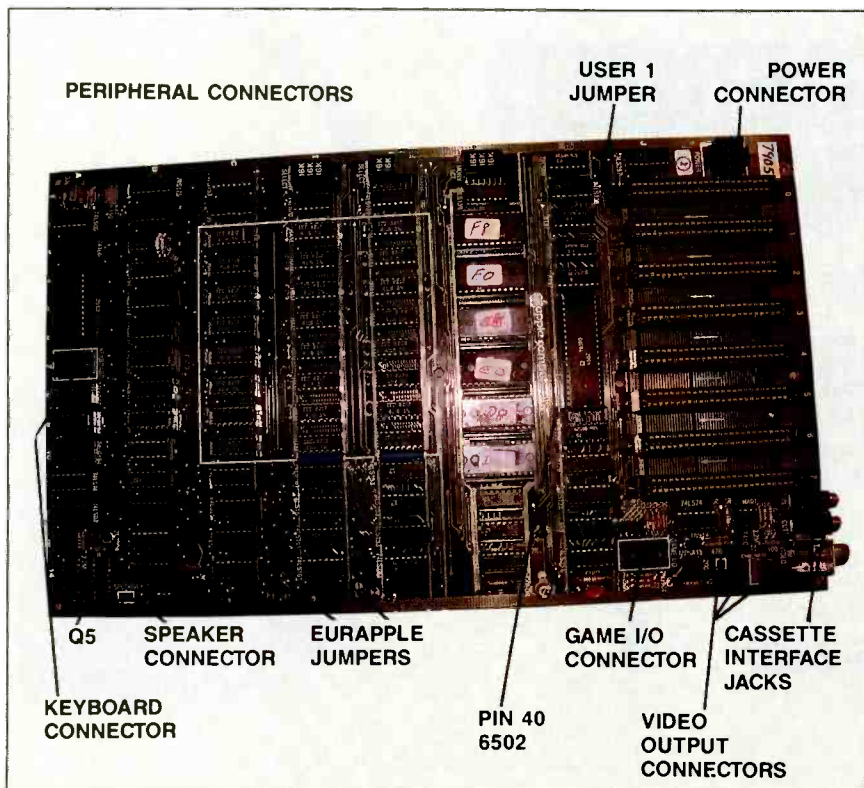

**Figure 1.** The Apple II+ is a single-board microcomputer with connectors that accept interface cards for connection to peripherals such as tape drive, disk drive, printer or modem. It is called *single-board* because all of the computer components (microprocessor, RAM, ROM and input/output interfaces) are contained on a single PC board. Arrows point to the areas mentioned in this article.





*Symptom: Computer locks up while executing a program.*

*Clue: Computer boots a system master disk but not a 48K slave disk.*

Examination of this computer determined that it would boot a system master disk but not a 48K slave disk—an important clue, because there is a difference between these two disks.

Before we continue, let's look at what is meant by booting and DOS, and examine what constitutes a disk. A floppy disk is a 5-inch, round piece of plastic film that is coated with a magnetic medium. The film is permanently sealed in a square jacket and allows rapid storage and retrieval of information. The program responsible for storing and retrieving information is called the *disk operating system* (DOS). *Booting* is the process of loading the DOS, which resides on the disk, into the computer. Once DOS is loaded, the information on the disk can be accessed.

A system master disk has self-relocating DOS that locates itself into the top of RAM, independent of the amount of RAM. RAM stands for random access memory or, more definitively, read/write memory. The Apple II contains 48Kbytes of R/W memory, which is divided into pages. Each page of memory has its own allocated function or functions. This is called a *memory map*. (See Figure 2.) The top 40 pages or top 10K of R/W memory is where DOS resides after it is booted from the system master disk.

A slave disk has DOS that is memory-size dependent. If a new disk is initialized on a 48K machine, it becomes a 48K slave disk. When it is booted, DOS will always be loaded into the top 10K of the 48K. It will not boot, for example, on a 32K machine. This characteristic provides a clue to the problem.

The symptoms point to some kind of R/W memory problem, so the first order of business is to boot a diagnostic disk and to execute a memory test. In

this case, doing so revealed that all memory in the range from 32K to 48K (top 16K or RAM) was bad. Because all 16K couldn't be bad, some study of the hardware was in order to determine a reason for this.

It turns out that there are three rows of memory ICs, and each row contains 16Kbytes of memory (3x16K=48K). (See Figure 3.) Each row is connected to a CAS (column address strobe) line. A unique range of 16K is selected by addressing one of these three lines. The three CAS lines come from a 74LS139 2- to 4-line address decoder located at F2 on the mother board. This IC decodes the address bus and provides active low outputs to indicate the state of the address bus. That is, one CAS line will go low when one of the three 16Kbyte ranges is addressed. Replacing the 74LS139 address decoder solved the memory problem.

SYSTEM MEMORY MAP		
Page Number:		
Decimal	Hex	
0	\$00	
1	\$01	
2	\$02	
RAM (48K)		
190	\$BE	DOS
191	\$BF	
192	\$C0	
193	\$C1	
I/O (2K)		
198	\$C6	
199	\$C7	
200	\$C8	
201	\$C9	
I/O ROM (2K)		
206	\$CE	
207	\$CF	
208	\$D0	
209	\$D1	
ROM (12K)		
254	\$FE	
255	\$FF	

**Figure 2.** The Apple II contains 48Kbytes of read/write memory, divided into pages. Each page of memory has its own allocated function or functions. This is called a *memory map*.

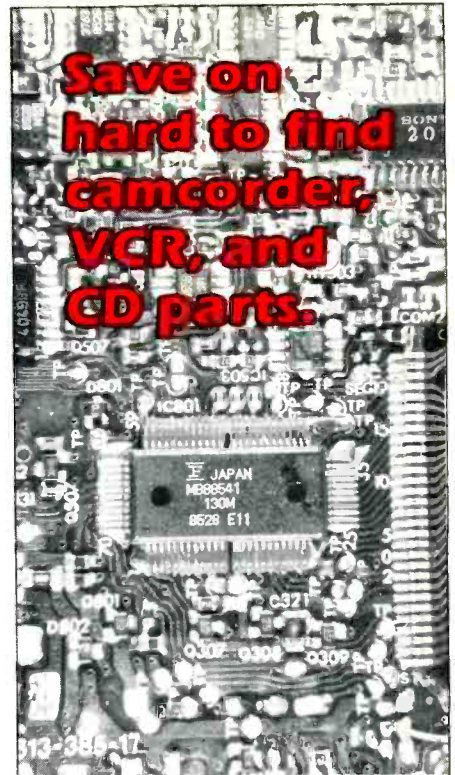

- SURFACE MOUNT DEVICES
- IDLER ASSEMBLIES
- BELTS
- LAMPS/SENSORS
- MOTORS
- INTEGRATED CIRCUITS
- CLEANERS/SOLVENTS
- CONNECTORS/CABLES

CALL TOLL FREE  
**1-800-338-0531**

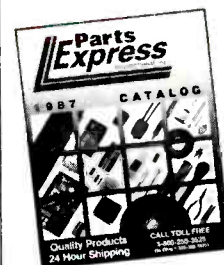

**FREE CATALOG**

**Parts Express**  
International Inc.

340 E. First Street; Dayton, OH 45402  
Local Phone: 513-222-0173  
FAX: 513-461-3391

Circle (16) on Reply Card

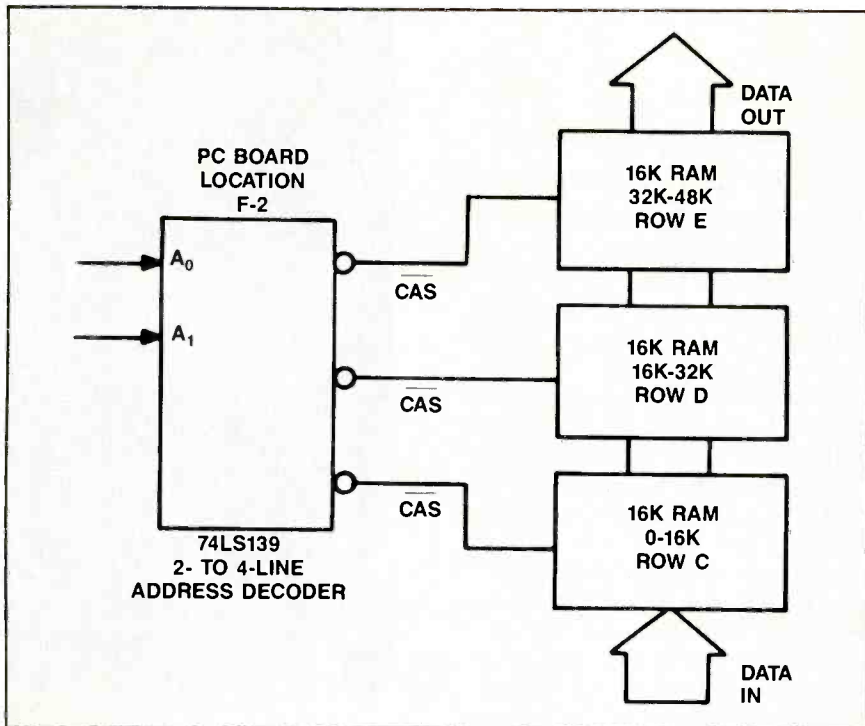

**Figure 3.** The RAM locations from which information is retrieved are selected via an integrated circuit known as a 2- to 4-line address decoder. If this device malfunctions it may appear that an entire section of read/write memory is defective.



*Symptom:* Computer hangs up (no cursor) when turned on; screen is full of garbage; disk drive won't boot; computer doesn't beep normally.

*Clue:* Computer operates when reset button is pushed.

This machine with a problem was an Apple II+ with an Autostart Monitor ROM (read only memory). The monitor ROM contains software that controls the computer, in the sense that it provides a cursor, accepts keyboard characters, displays characters on the screen, etc. Without a monitor ROM, the computer is worthless. "Autostart" means that it automatically boots a disk, provided a disk is in the drive, when the computer is turned on. Although the computer displayed the symptoms already lined out, the computer would operate fine once the reset button was pressed.

Because the computer worked once the reset key was pressed, there had to be a problem with the power-up reset circuit, which automatically initializes the  $\mu\text{P}$  at turn-on. Pin 40 is an active low reset pin on the 6502 microprocessor.

Figure 4 shows the reset circuitry that includes the reset key on the keyboard and the power-up reset circuit using a 555 timer. During the first 240ms or so after the Apple is turned on, the 555 timer causes pin 40 to be held low until all supply voltages and clock signals stabilize. Once the 555 times out, the reset line goes high and the computer will execute its start-up sequence. After the computer is on, it can be reset

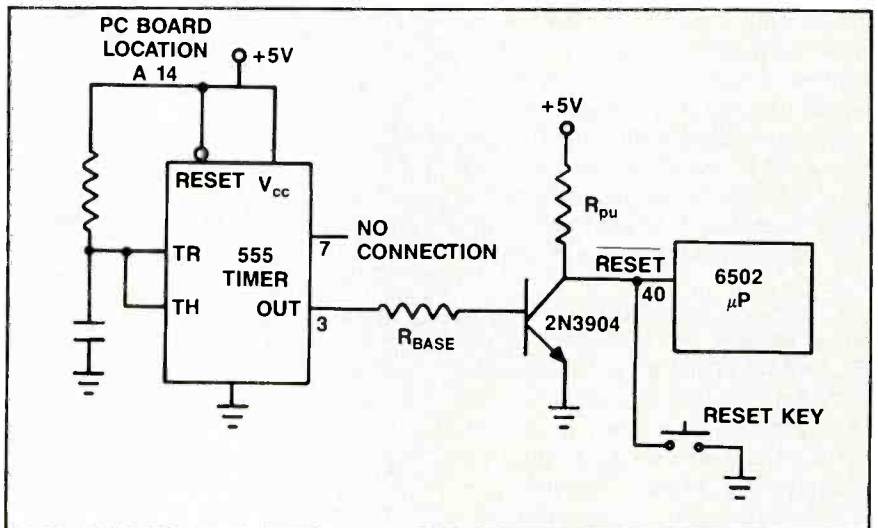

**Figure 4.** A simplified diagram of the power-up reset circuitry. Pin 3 of the 555 is normally at 0V, turning off the transistor and causing the signal at pin 40 of the 6502 to be high. During the first 240ms after the computer is turned on, the 555 timer causes pin 40 to be held low. After the 555 times out, the reset line goes high.

by pressing reset on the keyboard.

All the evidence indicated that the  $\mu\text{P}$  was being held in the reset condition. A voltage measurement at pin 40 of the  $\mu\text{P}$  read only 2.5V. This voltage is in the gray area of logic levels; it just might be low enough to constantly hold the  $\mu\text{P}$  in the reset state. Pin 3 of the 555 measured 0V (good) but the voltage at the base of the 2N3904, Q5, was 2V (bad). Leakage between the normally reverse-biased B-C junction of the 2N3904, the pull-up resistor and the base resistor formed a voltage divider. This resulted in 2.5V on the reset line instead of +5V. A new 2N3904 transistor solved the power-up reset problem.

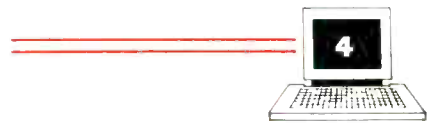

*Symptom:* Computer hangs up when turned on; screen is full of garbage; disk drive won't boot; computer doesn't beep normally.

*Clue:* No activity on address bus.

When the computer was turned on, it displayed a screenful of garbage, and it wouldn't boot a disk, accept any keyboard commands or display a cursor. An important difference from the previous example was that pressing the reset key had no effect.

A quick voltage measurement eliminated the reset circuitry as the cause of the problem (reset line was +5V). All



supply voltages and clock signals checked OK. The control bus signals nonmaskable interrupt, ready interrupt/request and direct memory access (NMI, READY, IQR and DMA respectively) also checked OK (all were in their non-active state or +5V).

As with many other computers, the Apple II contains three buses: the address bus, the databus and the control bus. Any one of the control-bus signals could have caused the computer to hang, but that did not turn out to be the problem. The address bus showed no activity at all. After a few more checks it was found that an IC known as a databus drive/transceiver (part number 8T28) located at H10 was defective. A new 8T28 solved the problem.



*Symptom: Computer won't accept characters from keyboard.*

*Clue: KBD line is always high.*

This one was a real challenge (or dog, depending on how you look at it), because the problem wasn't caused by an electronic device. The computer would not accept any characters from the keyboard, and pressing reset would cause the speaker to beep, which is normal. Then the computer would resort back to the "strange state": It would display six lines of garbage, then it would display, one by one, five more meaningless characters and then start the whole sequence over again. While in this state, the speaker would intermittently emit some awful sounds. Here's the kicker: Pressing reset would sometimes cause the computer to resort to its normal state and allow you to boot a disk and run a program. After a short time, however, the computer reverted back to the strange state.

Because the computer would sometimes act normal but then emit strange sounds and display garbage, it was apparent that the computer was not under program control of the F8 monitor ROM. If the computer isn't under control of the monitor, there must be a problem with the address bus. But how do you find a problem on a 16-bit address bus that travels all over the mother board? You can't ohm out each bus line to every connection they make.

Another approach needs to be taken

to tackle this dog. Remember when the computer wouldn't accept any characters from the keyboard? This is a good place to start, but first let's cover some operational basics of the Apple. (See Figure 5.) Keyboard data are multiplexed onto the databus when the KBD (keyboard) and RAMSEL (RAM select) lines go low. The KBD line is used to select between the keyboard data and the RAM data. The RAMSEL line enables the multiplexer and allows the selected data

to be placed onto the databus. When a key is pressed on the keyboard, its 7-bit ASCII byte is placed at the input of the data multiplexer and waits to be placed on the databus.

Let's continue with the keyboard approach. When the computer is operating correctly, there are pulses present on the KBD and RAMSEL lines. The pulses are selecting between RAM or keyboard data and multiplexing the selected data onto the databus. But during the



## Because Your Customers Deserve the Best



### Hitachi Original Replacement Parts

Quality, reliability, service... they're the touchstones of the Hitachi tradition, as recognizable as our trademark. And now those same standards that have earned us our reputation as a technological leader in consumer products, back up our new line of **Hitachi Original Replacement Parts**.

We know that for the service professional, time wasted is profit lost. Which is why Hitachi makes it easy for you. With our complete line of parts, we provide you with a single source for all your repair needs—and a profitable addition to your business. From VCR kits, IC chips and

diodes—to battery packs, video, audio accessories and technical publications.

What's more, our nationwide network of distribution centers means that you can get the parts and accessories you need, when you need them. And, of course, **Hitachi Original Replacement Parts** are included in our total service support program... because your customers deserve the best.

For more information, call toll-free  
**1-800-447-2882.**

**HSC SERVICE COMPANY**  
division of Hitachi Sales Corporation of America

401 W. Artesia Blvd.  
Compton, CA 90220  
(213) 537-8383

Circle (15) on Reply Card

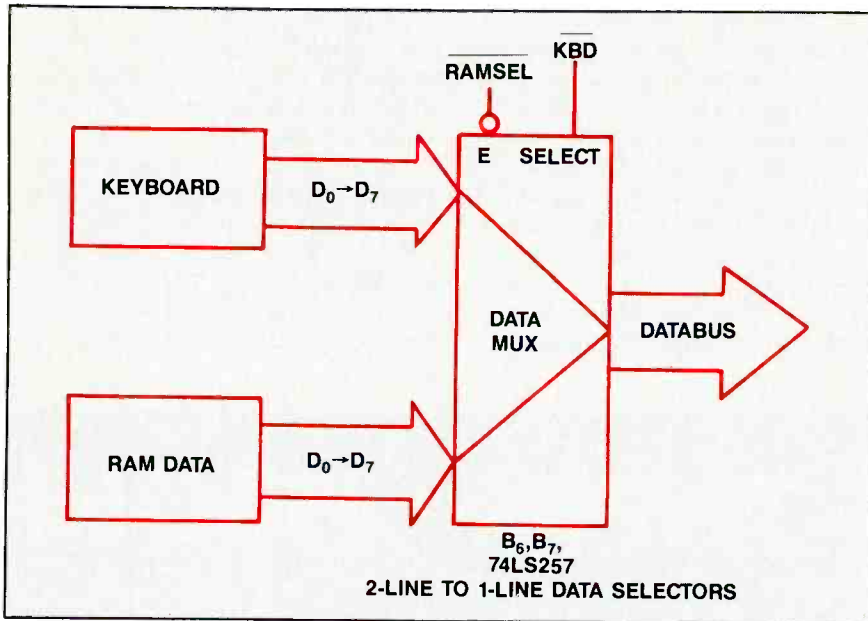

Figure 5. The data multiplexer selects between keyboard data and RAM data and connects the selected data to the databus.

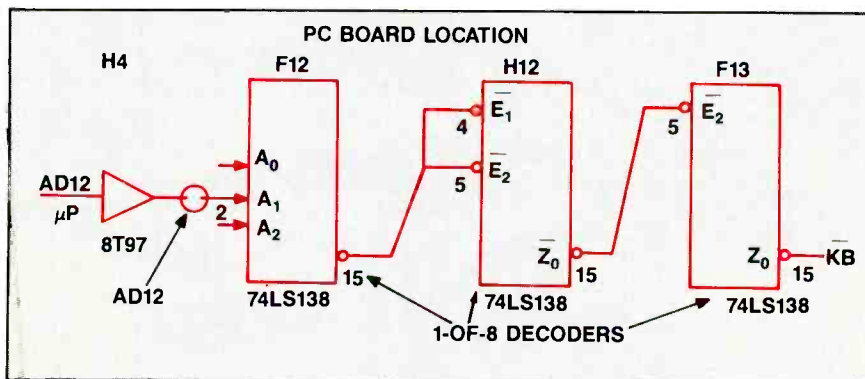

Figure 6. This simplified diagram shows the levels of address decoding that results in the KBD signal.

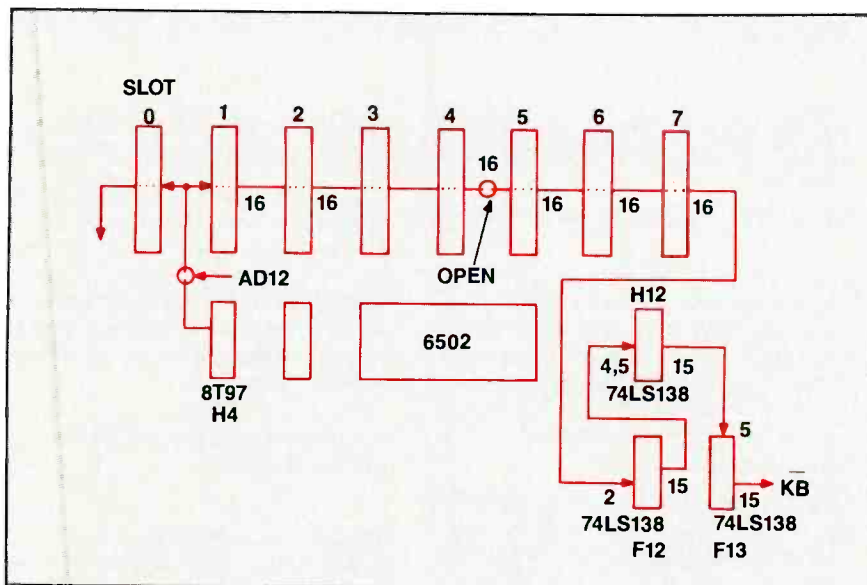

Figure 7. Locating the cause of a fault in a microcomputer may require tracing back through a number of components. In this case, failure of the computer to respond to keyboard inputs was caused by an open circuit well upstream.

“strange state,” the KBD line was always high. No wonder the computer didn’t accept any keyboard characters—it was never looking at the keyboard!

The keyboard is memory mapped, which means the Apple gets a character from the keyboard by reading a memory location. To read the keyboard data, the keyboard address (C000 hex) is placed on the address bus and is then decoded to create the KBD signal.

We know the KBD line isn’t going low, so what is causing it to stay high? (See Figure 6.) The KBD line comes from pin 15 of the 3- to 8-line I/O decoder (74LS138) located at F13. A little investigation showed that all the outputs of the decoder were stuck high. So far, so bad. All the input pins were found to be active except one—the active low enable at pin 5. It was always high. This signal comes from another 3- to 8-line decoder located at H12, pin 15. The same condition was found here. All outputs were high and all inputs were active except for the enable inputs at pins 4 and 5.

This line is connected to another 3- to 8-line decoder at F12, pin 15. Some of this IC’s outputs were active and some weren’t, including pin 15. The input lines were checked, and a problem was found at pin 2. The signal was active, but its logic level only had a low of 2V and a high of 3.5V.

We finally got it. Pin 2 is connected to address bus line 12 (AD12), which comes from the 8T97 address bus driver at H4, pin 3. There was a good active signal at the bus driver, which means only one thing—an open line between pin 3 of the bus driver and pin 2 of the decoder at F12. (See Figure 7.) AD12 travels from the bus driver to all the expansion slots, then down to the decoder IC at F12. The open was found between expansion slots four and five. A 2-inch piece of 30AWG wire between pins 16 (AD12) of these two slots solved this strange problem.

These case histories were presented to demonstrate the power of deductive reasoning. The key to troubleshooting any piece of electronic equipment is understanding how it operates, then analyzing the symptoms. Doing so will speed up repair time and give you a great feeling of accomplishment. Remember to always ask yourself—why?



# ZENITH PV800 SYSTEM SCHEMATIC

Product safety should be considered when component replacement is made in any area of a receiver. The shaded areas of the schematic diagram designate the components in which safety is of special

significance. It is recommended that only exact cataloged parts be used for replacement of these components.

Use of substitute parts that do not have the same safety characteristics as recommended in factory service information may create shock, fire, excessive x-radiation or other

hazards.

This schematic is for the use of qualified technicians only. This instrument contains no user-serviceable parts.

The other portions of this schematic may be found on other Profax pages.

8521  
Manufacturers' Schematics

**PROFAX**

3017

Zenith PV800 color monitor

January 1988

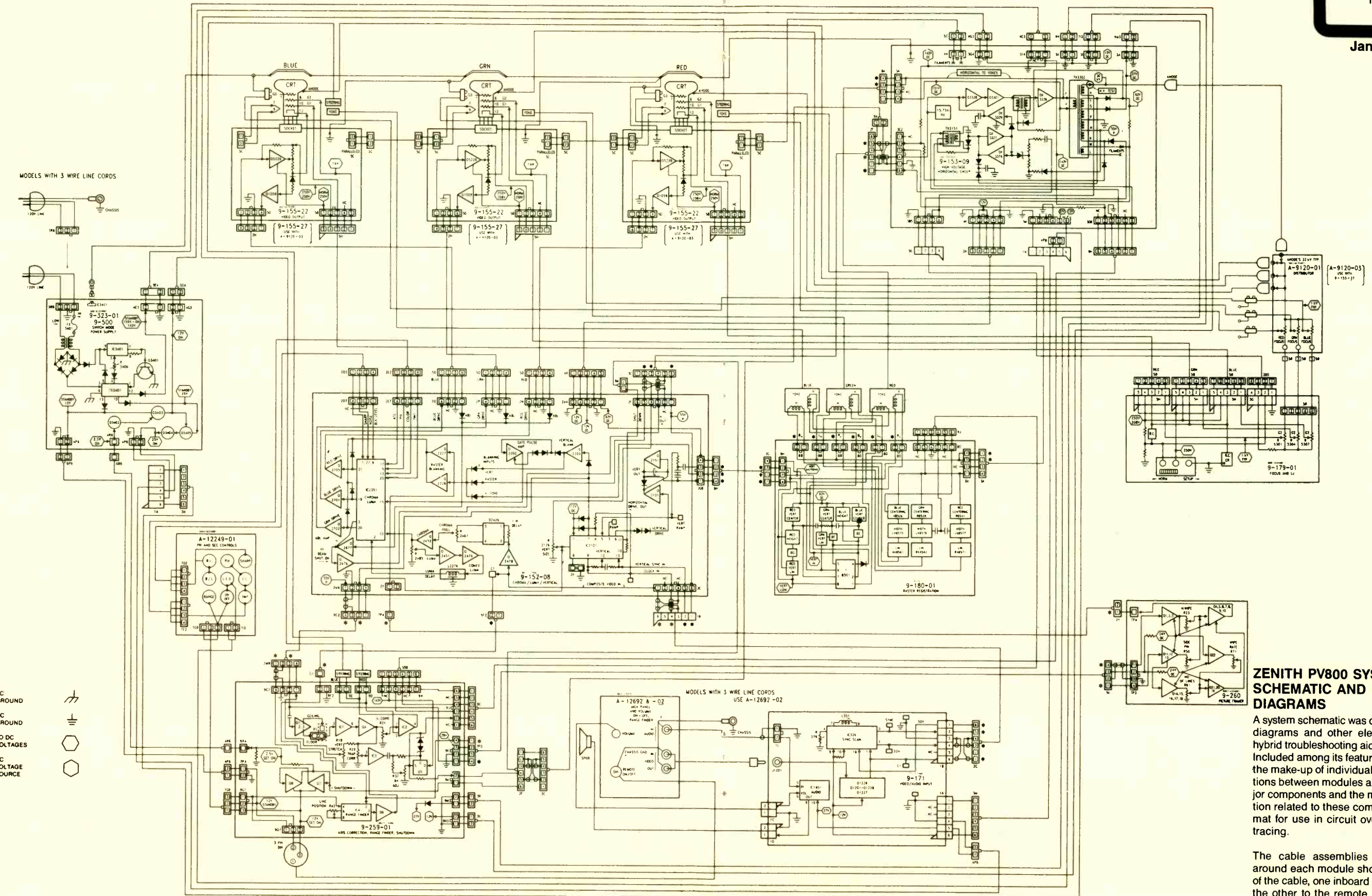

## ZENITH PV800 SYSTEM SCHEMATIC AND BLOCK DIAGRAMS

A system schematic was combined with block diagrams and other elements to form the hybrid troubleshooting aid seen on this sheet. Included among its features are key voltages, the make-up of individual cables, all connections between modules and assemblies, major components and the main lines of interaction related to these components. It is a format for use in circuit overviews and circuit tracing.

The cable assemblies illustrated at and around each module show both connectors of the cable, one inboard to the module itself, the other to the remote module.







### ZENITH PV800 CHROMA/LUMA MODULE SCHEMATIC

Product safety should be considered when component replacement is made in any area of a receiver. The shaded areas of the

schematic diagram designate the components in which safety is of special significance. It is recommended that only exact cataloged parts be used for replacement of these components.

Use of substitute parts that do not have the same safety characteristics as recommended in factory service information may create

shock, fire, excessive x-radiation or other hazards.

This schematic is for the use of qualified technicians only. This instrument contains no user-serviceable parts.

The other portions of this schematic may be found on other Profax pages.

### ZENITH PV800 CHROMA/LUMA MODULE SCHEMATIC

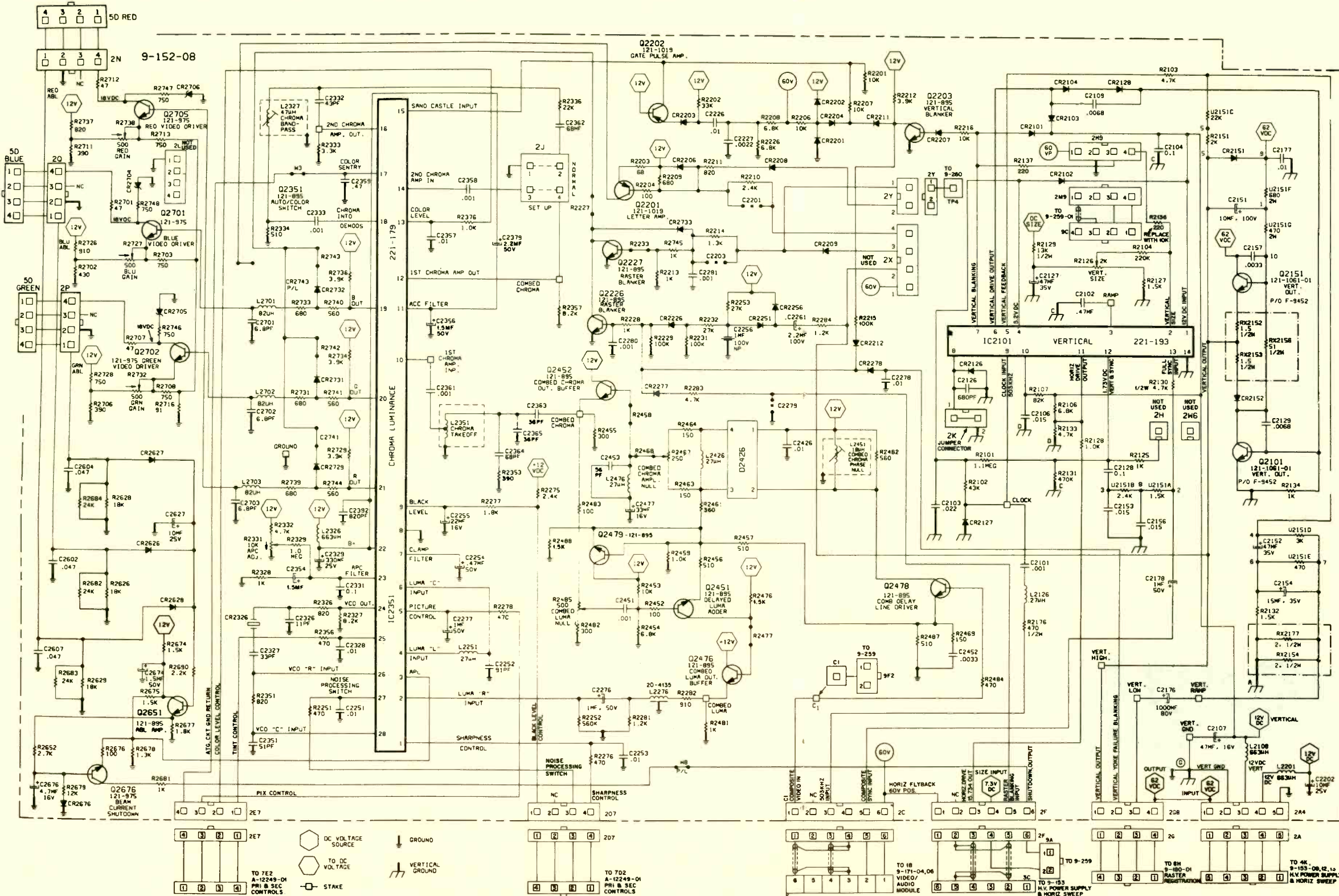

Product safety should be considered when component replacement is made in any area of a receiver. The shaded areas of the schematic diagram designate the components in which safety is of special significance. It is recommended that only exact cataloged parts be used for replacement of these components.

Use of substitute parts that do not have the same safety characteristics as recommended in factory service information may create shock, fire, excessive x-radiation or other hazards.

This schematic is for the use of qualified technicians only. This instrument contains no user-serviceable parts.

The other portions of this schematic may be found on other Profax pages.

- Notes:
1. Capacitance shown in microfarads unless otherwise specified.
  2. Resistors are 1/4W, film, ±5% tolerance unless otherwise specified.



ZENITH PV800 WAVEFORMS

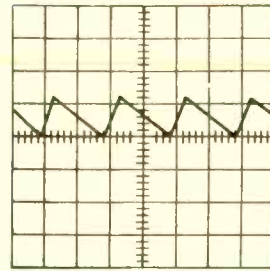

MODULE	CONNECTOR	PIN	AMPLITUDE
9-152-08	2GB	2	120 MV
9-180-01	BH	3	120 MV

VERT. 100mv /CM. HORIZ. @20µs /CM.  
WAVE FORM - VERTICAL SHUTOOWN

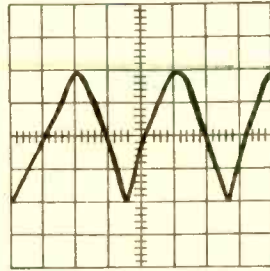

MODULE	CONNECTOR	PIN	AMPLITUDE
9-152-08	2GB	3	3.9V P.P
9-180-01	BH	2	3.9V P.P

VERT. 1V /CM. HORIZ. @5ms /CM.  
WAVE FORM - VERTICAL LOW

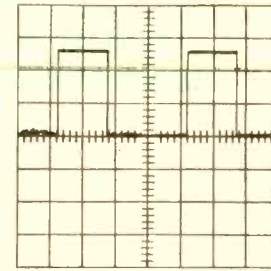

MODULE	CONNECTOR	PIN	AMPLITUDE
9-152-08	2C	5	2.6V P
9-171	1B	2	2.8V P

VERT. 1V /CM. HORIZ. @5ms /CM.  
WAVE FORM - VERTICAL SYNC

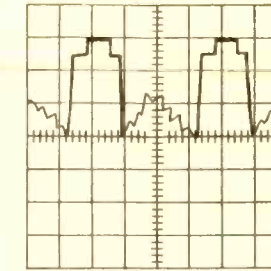

MODULE	CONNECTOR	PIN	AMPLITUDE
9-152-08	2C/C1	1	3 V.P
9-259-01	9F2	2	3 V.P
9-171	1B	8	3 V.P

VERT. 1V /CM. HORIZ. @10µs /CM.  
WAVE FORM - COMPOSITE VIDEO, RASTER ONLY

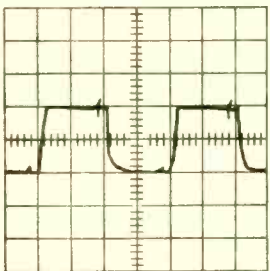

MODULE	CONNECTOR	PIN	AMPLITUDE
9-152-08	2F	3	2 V.P
9-153-09	3C	4	2 V.P

VERT. 1V /CM. HORIZ. @5µs /CM.  
WAVE FORM - HORIZONTAL DRIVE

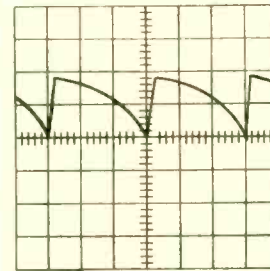

MODULE	CONNECTOR	PIN	AMPLITUDE
9-152-08	2F	5	9V P
9-153-09	3C	2	9V P

VERT. 3V /CM. HORIZ. @5ms /CM.  
WAVE FORM - RASTER BLANKING INPUT

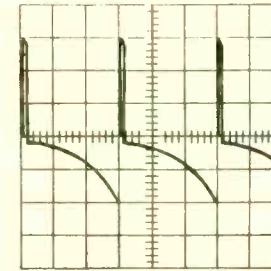

MODULE	CONNECTOR	PIN	AMPLITUDE
9-152-08	2GB	1	50 VP-P
9-180-01	BD	2	50 VP-P
9-180-01	BH	4	50 VP-P

VERT. 10V /CM. HORIZ. @5ms /CM.  
WAVE FORM - VERTICAL HIGH, OUTPUT

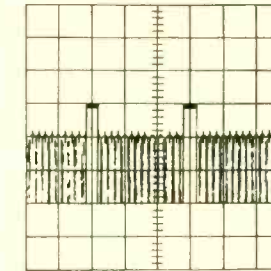

MODULE	CONNECTOR	PIN	AMPLITUDE
9-152-08	2C/C1	1	3 V.P
9-259-01	9F2	2	3 V.P
9-171	1B	8	3 V.P

VERT. 1V /CM. HORIZ. @5µs /CM.  
WAVE FORM - COMPOSITE VIDEO COLOR BARS ONLY

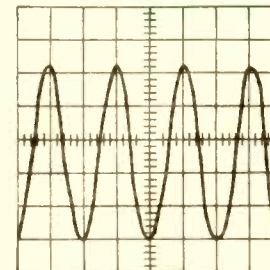

MODULE	CONNECTOR	PIN	AMPLITUDE
9-152-08	2C	3	1.1VP P
9-171	1B	4	1.1VP P

VERT. 200mv /CM. HORIZ. @1µs /CM.  
WAVE FORM - OSCILLATOR, CLOCK

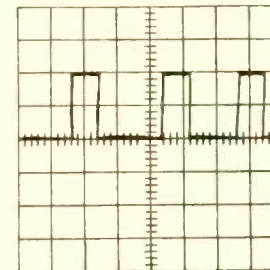

MODULE	CONNECTOR	PIN	AMPLITUDE
9-152-08	2Y	1	20 V.P
9-289	TP4	1	20 V.P

VERT. 10V /CM. HORIZ. @20µs /CM.  
WAVE FORM - HORIZONTAL BLANKING PULSE

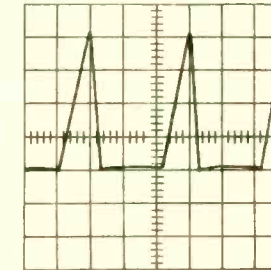

MODULE	CONNECTOR	PIN	AMPLITUDE
9-153-09	3A	1	1 K.V.P
9-180-01	8A	4	1 K.V.P
9-180-01	8B	2	1 K.V.P

VERT. 250V /CM. HORIZ. @2µs /CM.  
WAVE FORM - HORIZONTAL TO YOKES

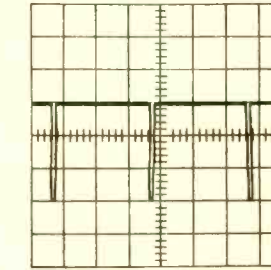

MODULE	CONNECTOR	PIN	AMPLITUDE
9-152-08	2M9	3	3 V.P
9-259-01	9C2	2	3 V.P
9-259-01	9K	1	3 V.P
9-280	TP3	4	3 V.P

VERT. 1V /CM. HORIZ. @5ms /CM.  
WAVE FORM - VERTICAL BLANKING

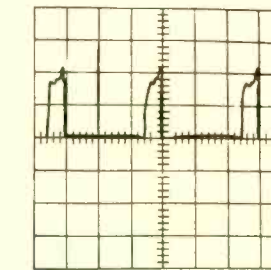

MODULE	CONNECTOR	PIN	AMPLITUDE
9-152-08	2C	6	55 V.P
9-152-08	2F	1	55 V.P
9-152-08	2M9	1	55 V.P
9-153-09	3C	6	55 V.P
9-259-01	9C2	4	55 V.P
9-259-01	9K	4	55 V.P
9-280	TP3	1	55 V.P
9-171	1B	1	55 V.P

VERT. 25V /CM. HORIZ. @20µs /CM.  
WAVE FORM - FLYBACK PULSE

HITACHI CT1358 BASIC CIRCUIT DIAGRAM

- Because this is a basic circuit diagram, the value of the parts is subject to be altered for improvement.
- All dc voltage to be measured with a tester (100kΩ/V).
- Voltage taken on a complex color bar signal including a standard color bar signal.

Product safety should be considered when component replacement is made in any area

of a receiver. Components marked with a ! and shaded areas of the schematic diagram designate sites where safety is of special significance. It is recommended that only exact cataloged parts be used for replacement of these components.

Use of substitute replacement parts that do not have the same safety characteristics as recommended in factory service information

may create shock, fire, excessive x-radiation or other hazards.

This schematic is for the use of qualified technicians only. This instrument contains no user-serviceable parts.

The other portions of this schematic may be found on other Profax pages.

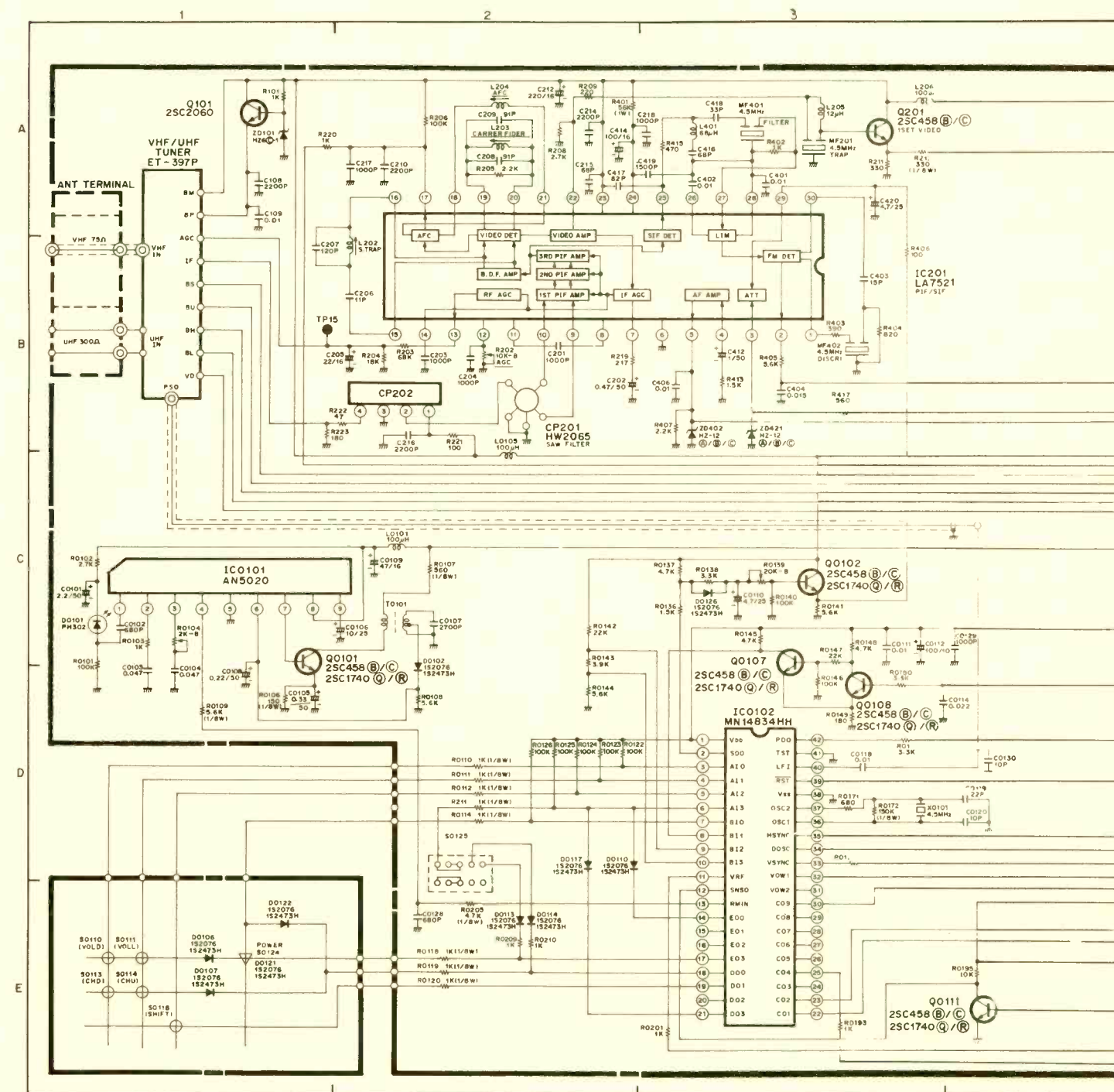

Reprinted by permission of the Hitachi Corporation of America  
Copyright 1988, Electronic Servicing & Technology, P.O. Box 12901, Overland Park, KS 66212.



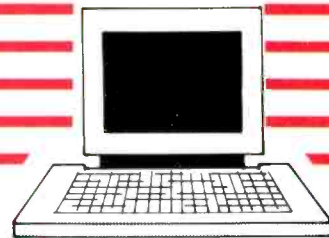

# Servicing the Commodore 1541 disk drive

By Andy Balogh

The Commodore 1541 disk drive is similar to most other personal computer disk drives in the way it stores data on the magnetic disk and retrieves that data. It is very different from most other PC disk drives in the way it is controlled.

Most other disk drives are controlled directly by the computer. The software that performs this control, the disk operating system (DOS), is read from a disk during the computer startup operation and stored in the computer's read/write memory (RAM). In contrast, the control of the 1541 disk drive comes from a microcomputer in the drive itself. The microcomputer gets its instructions from a program that is permanently stored in a read-only memory

chip in the disk drive.

This article generally describes the components and function of the Commodore 1541 disk drive, lists some of the more common malfunctions, and shows how to troubleshoot and correct these problems.

Two earlier articles might enhance your understanding of this subject: "Understanding the Floppy Disk" in the April 1985 issue and "Servicing the Commodore 64" in the March 1986 issue.

## How disk drives work

The function of the disk drive is to magnetically store and retrieve computer data onto or from a floppy disk. The disk drive takes the advantages of a phonograph record and a tape recorder and combines them into one computer-controlled unit. The advantage of tape

over the phonograph record is that you can record as well as play back a particular piece of music. The advantage of a phonograph record is that you can move the tone arm to a particular track.

The data on the disk also is stored much like on a phonograph record. (See Figure 1.) There are a number of concentric circles, each one bigger than the last, each independent from the other. These circles are called *tracks*. Track 1 is the outermost track, located at the edge of the disk. Track 35 is the innermost track, located near the *hub* or inner edge of the disk. The center track is 18, which is used for disk organization, sometimes called housekeeping.

The jacket of the disk has several cutouts in it. The *head-access slot* allows the disk drive head to touch the

Balogh is an instructor at the Electronic Servicing Institute in Cleveland, OH.

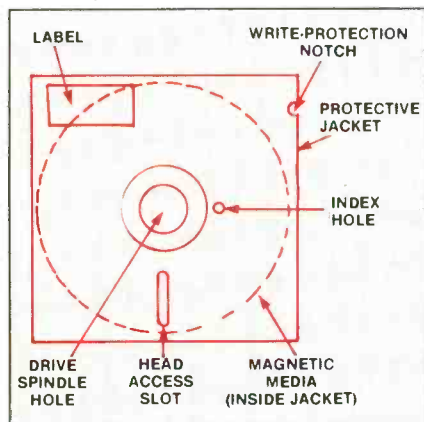

Figure 1. Personal-computer information is stored permanently on a floppy disk, which consists of a circular piece of plastic film with a layer of magnetic medium, much like magnetic tape. The disk is divided into blocks. Each block is the area where a pie-shaped sector and a circular track intersect.

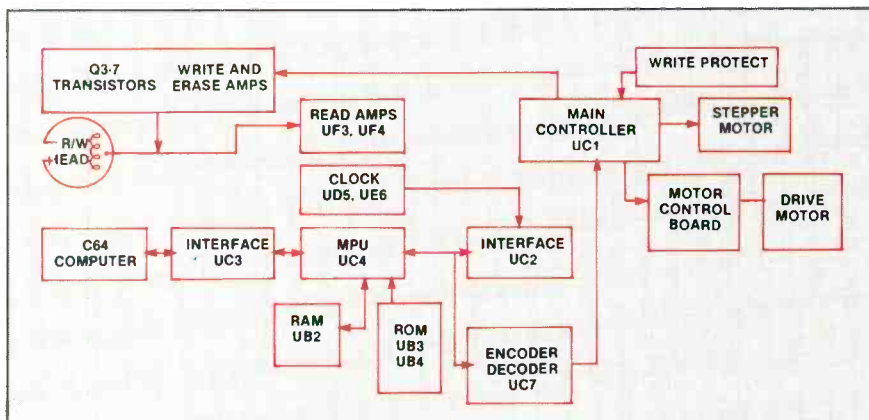
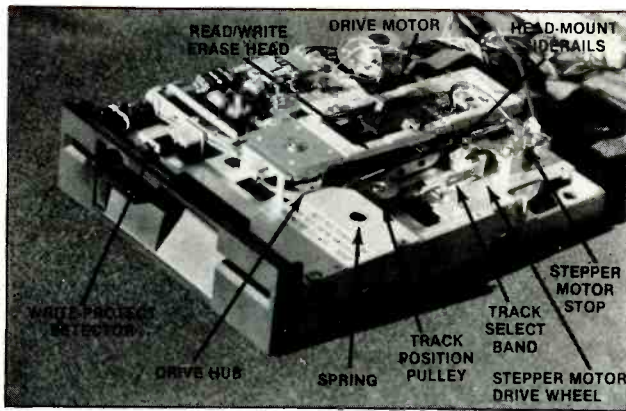
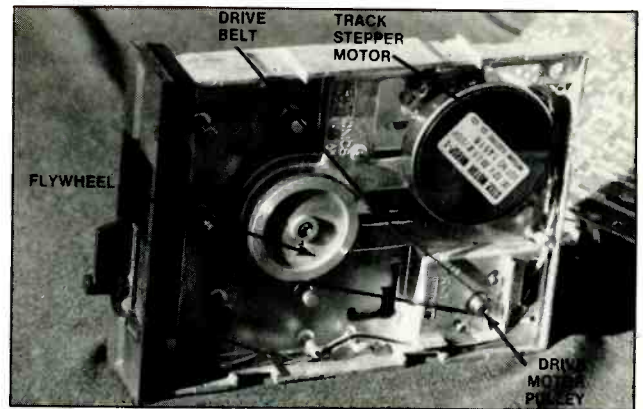

Figure 2. The functional relationships of circuits in the 1541 disk drive are shown in this simplified block diagram.



**Figure 3.** The disk drive is a complex electromechanical device. The arrows point to some of the more important mechanical components.



**Figure 4.** This bottom view of the disk drive shows the track stepper motor, the drive-motor pulley, the drive belt and the flywheel.

magnetic coating. The *write-protect notch* protects a disk against accidental erasure or overwriting. If the write-protect is left uncovered, writing to the disk is permitted. If the write-protect notch is covered, writing is disabled. This type of protection is similar to that used in audio and video cassettes. (However, if the write-protect circuitry is defective, it is possible for disks to be damaged by erroneous information being written onto the disk, even though the notch is covered. For that reason, make sure you use "scratch" disks when servicing and have a couple of backup disks ready for test programs.)

A disk drive basically consists of two main units. One is a mechanical unit composed of belts, motors and pulleys. The second is an electronic unit composed of solid-state circuits and a program called the disk operating system (DOS), which controls its operation. (Figure 2 shows the relationships between the circuitry.)

### The mechanical unit

The mechanical part of the disk drive (shown in Figure 3), which includes the belts and motors mentioned before, includes the following parts:

- The *read/write/erase head* is basically a magnetic recording, playback and erase head similar to the head used in an audio recorder. This head must position itself over various tracks as directed by a program. The head is actually composed of two heads: the full erase head and the read-write head.
- The *head-mount siderails* allow the head to move freely across the diameter of the disk. A build-up of dirt on these rails can cause read errors.
- The *track select band* is a metal band that moves the head.
- The *stepper motor drive wheel, track*

*position pulley* and *spring* all interact to move the head into the desired reading or writing positions.

- The *stepper motor stop* prevents the stepper motor from overrunning the outermost track (track 1).
- The *drive motor* rotates the disk. It must do so at a precise speed: 300rpm. This allows the drive to locate a particular sector; it also allows the disk to be read by another drive.
- The *drive hub* is attached to the drive flywheel. Its purpose is to sandwich the disk between itself and the drive idler, called the pressure cone; this forces the disk to rotate.
- The *write-protect detector* is an optical switch. If the write-protect notch on the disk is open, the write-protect detector has no effect on the writing process. This is because the infrared light is unobstructed and is sensed by the phototransistor permitting the DOS to write. However, if the write-protect notch is covered with opaque tape, the write-protect detector will disable the DOS from writing.
- Underneath the mechanical unit (see Figure 4) is the *track stepper motor*, a special type of motor used to precisely position the read/write head. A stepper motor does not rotate like a regular dc motor, but instead turns in increments of a revolution. The more increments a stepper must make for one complete turn, the more accurately it can position the head.
- The *drive belt* connects the drive motor pulley to the flywheel. The flywheel smooths out the motion of the drive hub. A timing disk on the flywheel provides a reference for calibration of disk drive rotational speed.

There are two types of mechanical units used. First is the Alps unit, which has a spring-loaded latch on the door

used to insert and remove the disk. (See Figure 3.) This type of assembly also uses an eject mechanism. Second is the Newtronic unit, in which a lever is used to lock a disk into position. An eject mechanism is not used and the disk must be manually removed.

### The electronic unit

The electronic part of the drive consists of two boards. First is the motor drive board, which controls the speed of the drive motor. In older units it is located on the underside of the mechanical unit adjacent to the flywheel. In newer units it is located on the top side. The second board is the disk controller card (sometimes called the analog card). The disk controller card contains a dc power supply and seven computer-controlled circuits:

- the *timing circuit*, which simply produces the clock signals;
- the *serial bus control*, which organizes all the operations of the disk drive;
- the *optical circuitry* used in conjunction with the write-protect detector;
- the *read circuitry*, which controls the playback of digital information;
- the *write circuitry*, which controls the recording of digital information;
- the *track-select circuitry*, which controls the stepper motor; and
- the *encoder-decoder circuitry*, which detects the presence of data and performs a serial-to-parallel conversion within the drive's computer.

Commodore has revised its disk controller card no less than five times. Some of these revisions have their own particular problems not related to other boards. The first and second revisions, called the 1540 and the 1540 revised boards, respectively, fill the entire top of the drive unit. The third and fourth



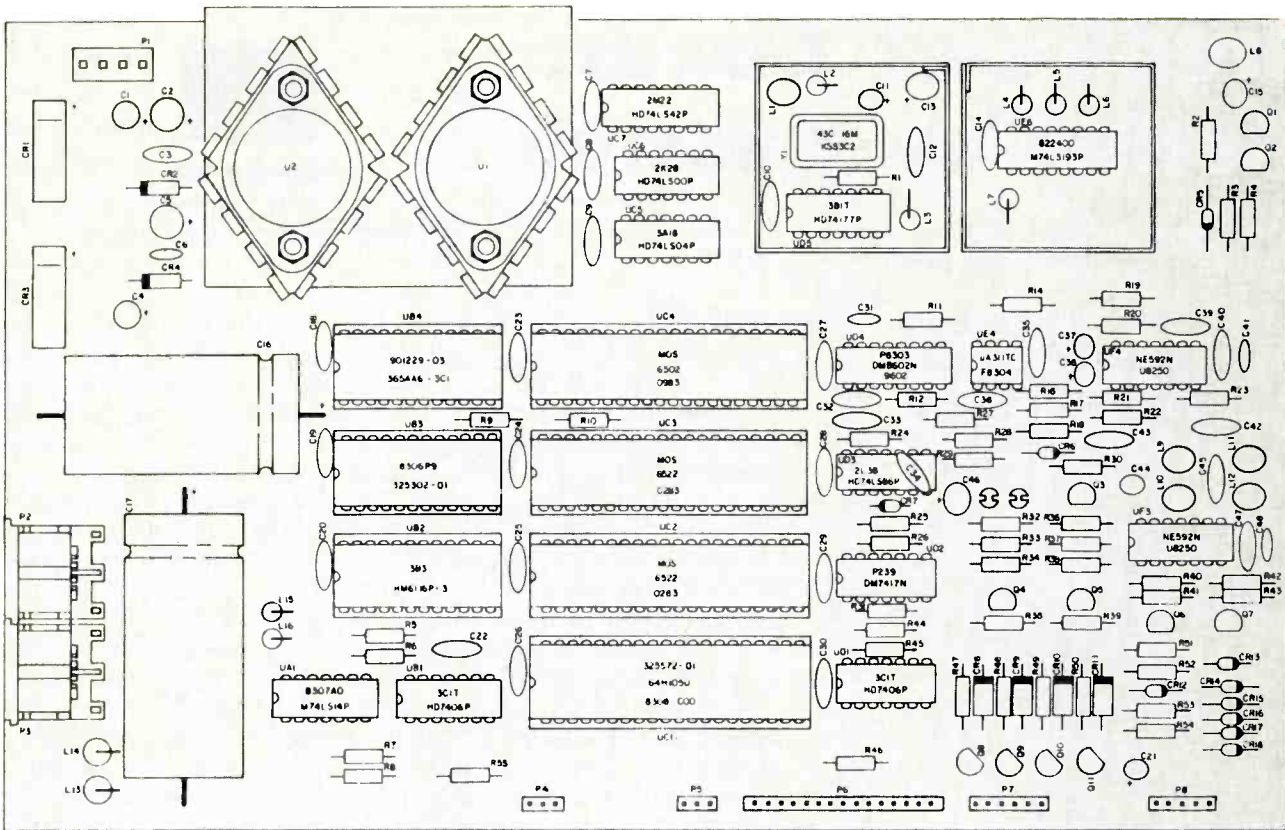

**Figure 5.** The Commodore disk-drive controller board has been revised a number of times. This is the 1541 board, which has fewer components but larger-scale ICs.

revisions are the 1541 and 1542 boards, which fill approximately 75% of the top unit and contain fewer components but larger-scale integrated circuits. (The 1541 board is shown in Figure 5.) Finally, the 1542C board is a half-board with more densely packed chips.

### Accessing the drive

If the computer, drive and monitor are connected and there is a disk in the drive, typing LOAD "\$", 8 (RETURN) will load the listing of file names into the computer from the disk. To display the listings, simply type LIST (RETURN).

The drive will go to and read track 18, which is set aside by the DOS for disk organization. Track 18 is automatically managed at all times by the DOS. The file names and disk name displayed is called the *directory*. The numbers displayed to the left of the file names is called the block availability map (BAM). The BAM tells you how many sectors are free (blocks free at bottom of directory). Track 18 should be the easiest track for the drive to read because it is in the middle of the disk.

Formatting a disk erases the entire disk; it also puts timing and block

markers on the disk and creates the directory and BAM. The command for formatting is:

```
OPEN 15,8,15"NO: FILENAME, ID":
CLOSE 15
```

The name entered as the file name becomes the name of the disk. The ID is any two characters, and they are placed not only on the directory, but on every block throughout the disk. That way, if you mistakenly replace the wrong disk while writing data, the drive will check the ID and know that something is wrong. This is important to remember when troubleshooting a "drive not ready" error with the disk inserted. This command is also useful in troubleshooting a writing problem.

Sometimes an error condition will stop the disk drive in the middle of an execution. This is indicated by a flashing red LED. To read the error message that caused the failure, enter the following basic program into the computer:

```
10 OPEN 15,8,15
20 INPUT #15,A$,B$,C$,D$
30 PRINT A$, B$, C$, D$
RUN
```

After RUN is entered, the error message should be displayed and the error light should stop flashing. The error message displayed may give you a clue as to why the drive failed.

At times, an error condition will exist that will prevent you from performing some disk operations. A command called the initialize command returns the disk drive to the same state as when you powered up. That command is:

```
OPEN 15,8,15: PRINT # 15: CLOSE 15
```

It also repositions the read-write head so it is in the track 18 position. (Please note: When typing in any of these programs, leave no spaces between characters.)

### Editor's note:

This article should give you enough information to help you understand the general operation of the 1541 disk drive. Part II, which will appear in the February issue, will cover troubleshooting and repairing the mechanical section of the unit and will include an analysis of problems and solutions for the electronics section.



# Break-out boxes: Active vs. passive

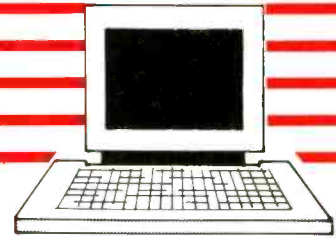

By Manfred R. Will and Cindi L. Kemper

For years, the active vs. passive debate surrounding break-out box design has been a familiar topic among many top technicians and service managers in the data communications troubleshooting and interfacing industry.

These differences translate into definite advantages and sometimes disadvantages, which experienced technicians should know and be able to use to their own advantage. The added advantage that comes with using the appropriately designed break-out box easily can equate to greater efficiency and information—information that means time savings.

Simply put, the base argument still centers on the method by which LEDs (light emitting diodes) on the break-out box are powered. There are two basic approaches to powering a break-out box: One way is to power the unit with a battery; the other is to take power from the system being tested.

An *active* box, by definition, is one that uses a buffer or amplifier of some form to drive the LEDs. The power needed to do this generally is provided by one or more internal batteries.

A *passive* box, on the other hand, is one that draws its power from the signal line itself. This design, in turn, serves to power LEDs without using any outside power. There is no dependence on a battery to help the break-out box function.

Unfortunately, that's where the definition stops and the debate begins, because there's really no right answer. Supporters argue both sides, and pros and cons exist for both designs. Anyone contemplating a break-out box purchase should take time to understand both the ad-

vantages and disadvantages of each.

## Active design

One school of thought argues that test equipment should be transparent to the operation of the equipment being tested. False or ambiguous readings, which are caused by the testing unit loading down the system, are unacceptable, so for complex and intermittent problems, an active device should be used.

Classical engineering philosophy would support the concept that any device designed to measure the status of another device should not in any way affect the device being measured. This theory has its followers and would tend to support an actively designed box. (The technical explanation of this theory is expanded later in this article.)

On the other hand, a passively designed break-out box also has its supporters. Because a passive box is capable of reporting the relative signal strengths of each line in use, a great deal of added information suddenly is available at the technician's fingertips. Many technicians feel this additional information, along with its independence from an internal power source, far outweighs any question of impedance level. Besides this, new designs in break-out box construction are drawing as little as 2mA or less off the line.

To really understand the basis of this debate, a quick overview of the RS-232 protocol from a more technical point of view may be helpful. RS-232 is probably the most common protocol for serial data communications between computers and peripherals.

This standard calls for both positive and negative voltage transmission, typically +12V or -12V. A positive signal is +3V to +12V, a negative signal is -3V to -12V, and anything between +3V and

-3V is a disallowed state. Integrated circuit manufacturers have responded to these standards with a pair of ICs (a transmitter and receiver) to handle the electrical characteristics of RS-232C.

An RS-232 transmitter (i.e., quad line driver No. 1488) is designed to convert up to four TTL signals into +12V or -12V levels with the output current limited to 10mA. The receiver (i.e., quad line receiver No. 1489) converts up to four RS-232 signals back into TTL levels and typically exhibits an input impedance level between 3k $\Omega$  and 7k $\Omega$ .

These specifications describe the foundation that supports the classical engineering philosophy. The ra-

## How they work

The connections between a computer and its peripherals or between a computer and data communications equipment are complex. When problems occur at these interfaces, it often is necessary to use some kind of test device to monitor the signals and determine the cause of the problem. When this interface is a serial interface to which the EIA recommended standard RS-232 applies, a commonly used testing device for this purpose is the break-out box.

In operation, the break-out box is connected to both sides of the interface. For example, if the problem is with a printer interface, one side would be connected to the computer and the other side to the printer. Connected in this manner, all communications lines would flow through the break-out box. Red and green LEDs on the box then show whether positive or negative signal voltage is present on each pin, on each side. (For a more detailed description of this interface, see "Testing Serial Communication With a Break-out Box" and Computer Corner in the February 1987 issue.)

Will is vice president of engineering and Kemper is vice president of international sales and marketing for Datatran, Denver, a manufacturer of break-out boxes.



ditional here implies that an input buffer with a relatively high input impedance level, say several 100k $\Omega$ , would not affect or load down the signal under test. These buffers are typically of a digital rather than linear (analog) design and are therefore set to turn on at a predefined threshold point (usually +3V for positive signals and -3V for negative signals).

These buffers are capable of outputting 10mA to 30mA, so standard LEDs, which require 20mA for rated intensity and are more cost-effective from a manufacturing point of view, may be used. Because of the digital function of the buffer within an active-designed break-out box, all signals above the threshold voltage of the buffer will produce a bright, visible indication on its respective LED.

Some technicians prefer an actively designed box because they require brightly lit LEDs. But today, a number of passive boxes use new high-efficiency LEDs, which nearly equal the intensity of those in a buffered design even though no outside power source is being used.

#### Passive design

A passively designed box has its advantages as well. Returning for a moment to classical engineering philosophy, a device designed to test the performance of another device probably would affect or interact with the device under test. The rationale here is that a passive design (an LED combined with a series, current-limiting resistor that is placed across the circuit under test) derives its power from the circuit and should provide a reasonable load to the circuit.

Where the RS-232 protocol is concerned, a reasonable load would be equivalent to the input impedance of a 1489 receiver. The desired response in this case would be a reasonably bright LED indica-



tion. Because 1488 drivers are current-limited to 10mA and standard LEDs require about 20mA for rated intensity, an obvious problem exists.

Advances in LED technology throughout the last several years have led to the development of special high-efficiency LEDs. With only 2mA, these LEDs will demonstrate an equivalent brightness to conventional LEDs using 20mA. What all this means is that you can place a typical RS-232 receiver load on an RS-232 driver and see the result.

The advantage to this type of design is its ability to point out potential hardware problems or flaws. For example, a defective driver, which cannot supply rated current, can be quickly and easily detected. Another benefit inherent to a passive design is that the relationship between signal voltage and LED intensity is a linear one. As the signal voltage decreases, so does the LED's intensity, which provides a quick visual indication of relative signal strength. A 4V signal on an active box may be easier to see, but

you would never know that a potential problem exists. The ability to measure while testing can be a real benefit in some cases.

Perhaps one of the most important benefits is a passively designed box's independence from batteries. Untold numbers of technicians have found themselves in the field only to discover they are unable to use their break-out box because of worn out or low batteries. A passively designed box always is dependent solely on the power from the interface and thus eliminates any dependence on outside sources.

The active vs. passive debate continues to recruit new support on both sides. Perhaps now you have a better understanding of the advantages of each. Five years ago, when most passive break-out boxes were inefficient and active break-out boxes were just being introduced, technicians probably would have opted for an active design. But today, because the method of break-out box construction has changed, components are more efficient and technicians are open to new ideas. The debate continues.

**ES&T**

# The logic probe: Troubleshooting to the component level



By Conrad Persson

Servicing personal computers has typically been a matter of locating the problem at the PC-board level and then replacing that board. Taken on a case-by-case basis, this approach seems quick and efficient. The inefficiency in this approach, which is not readily apparent, is the investment in keeping a stock of spare boards on hand. Another problem is that a board that appeared to be faulty turns out to be perfect.

The solution to this problem is to troubleshoot down to the component level and replace faulty components instead of board swapping. In some cases, this approach can require some sophisticated and expensive test equipment. In other cases, however, some very simple test equipment will do the job, or you might be able to find the faulty component without any test equipment at all (as mentioned in the Apple computer servicing article, page 24).

Persson is editor of *ES&T*.

The logic probe, shown at left, indicates whether the logic state of the point being tested is at a logic high or low. A sophisticated probe will have indicators to show whether the test point is high or low or is exhibiting pulses. Some will even have a memory or pulse stretcher that will show the presence of a 1-shot pulse that is of so short a duration that it is insufficient even to light the indicator, or it lights the indicator too briefly to be recorded by the human eye.

The indicators used to show the logic state of the pin being tested are usually LEDs. In some cases, a single LED is used to indicate any of the conditions (high, low or pulsing); in other cases, individual LEDs are used for each indication.

Let's say you're troubleshooting using a sophisticated logic probe that is capable of testing a number of different kinds of logic circuits: TTL, DTL, CMOS. You would connect the probe's power input to the power supply from

The logic probe can help a skillful technician troubleshoot a digital circuit down to the component level. The probe lets the technician know what kinds of signals are appearing at the pins of the ICs in the circuit. (Photo courtesy of Phillips ECG)

A test unit such as this can apply test signals and interpret results by exercising a PC system through its I/O connections. It then outputs a message to guide the technician to the suspect pins of the suspect components. (Photo courtesy of Vu-Data Corp.)





# Discover How The World's Only 100% Automatic, Dynamic, & Portable LC Analyzer Gives You Total Confidence In Your Cap/Coil Testing . . . Call 1-800-843-3338 Today!

which the circuitry being tested derives its power. Connecting the probe in this manner will indicate the approximate value of signal voltage that constitutes a logic low or high.

For example, the power-supply voltage for a CMOS logic circuit is 18V. A logic low in this circuit would be about 30% of that value or 5.4V. A logic high in this circuit would be about 70% of 18V or approximately 12.6V.

If you suspect a specific IC, it would make sense to go directly to that IC once you have the logic probe connected in to the circuit's power supply. Otherwise, use the time-tested method of starting approximately in the middle of the circuit, and let the results at the point guide you upstream or downstream a half-circuit at a time.

## Guided fault isolation

The logic probe all by itself is a valuable diagnostic tool. With a little help, it can be even more useful. One of the logic circuit testers that can help a technician use a logic probe to locate a faulty component is a guided fault-isolation unit. This unit connects to the PC system board input/output connectors and, armed with the proper software, goes through a step-by-step test routine that exercises the computer circuits. When it encounters a condition that casts suspicion on that circuit segment, it outputs a message that tells the operator to check the condition of a specific pin of a specific IC.

## Your choice

Just as with the servicing of television, audio and other consumer electronic equipment, servicing of PCs can be done on just about any level. You can swap boards (where the product is modular) or troubleshoot to the component level. If you choose to troubleshoot to the component level, you can use simple, inexpensive test equipment or more sophisticated, expensive test equipment. Whichever you choose, the most important thing to bring to the test bench is good, solid information about the equipment you're servicing and sharply honed troubleshooting skills.



**New**

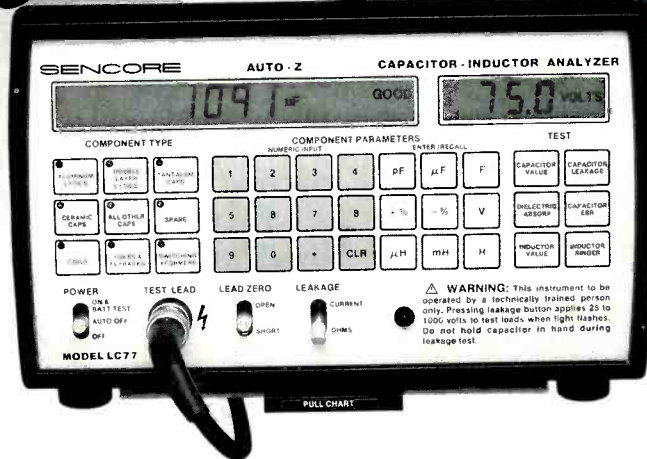

**LC77 AUTO-Z™**  
Automatic Capacitor and Inductor Analyzer  
Double Patented \$1,895

IEEE - 488

The first cap/coil analyzer guaranteed to reliably test anywhere, without calculations, look-up tables, or error — 100% automatically so you're confident of your accuracy.

Do you want to eliminate doubt from your cap/coil testing? The LC77 AUTO-Z tests all key parameters with results anyone can understand. Automatic good/bad results eliminate the guesswork for error-free analysis. Touch-sensitive keypad and one-two-three setup makes your AUTO-Z the easiest and fastest LC analyzer on the market.

Are you frustrated trying to test the new high-tech caps/coils used in modern electronics? Only the LC77 AUTO-Z allows you to test them all. Test capacitors from 1 pf to 20 farads, with leakage tests to 1000 V and ESR to 2000 ohms for locating failures other testers miss. Inductor value from 1 uh to 20 H and a patented ringing test for dependable, error-free coil testing every time.

Do you need the freedom of a battery-operated portable LC meter? The LC77 is 100% battery portable for use in the field or factory. The full power and potential of the LC77 AUTO-Z is packed into a light-weight, portable package. The AUTO-Z puts the complicated electronics on the inside for ease of operation on the outside.

Do you want maximum efficiency with a bus compatible LC testing system? Your LC77 AUTO-Z is IEEE 488 compatible for automated cap/coil analysis for data collection, incoming inspection, and quality assurance tests.

Be satisfied that you can meet all the challenges new technology brings. Call WATS Free 1-800-843-3338 today and tell your Area Sales Engineer you want to "try before you buy" with Sencore's exclusive 10 Day Self Demo.

AUTO-Z is a trademark of Sencore, Inc.

WATS Free 1-800-843-3338 In Canada WATS Free 1-800-851-8866



# SENCORE

Means Success In Electronic Servicing

3200 Sencore Drive, Sioux Falls, South Dakota 57107

Call Collect 605-339-0100 In SD & AK

Circle (17) on Reply Card

# What do you know about electronics? --

## We get letters

By Sam Wilson

In the last few months, I've received many interesting and informative letters. Because they are informative, I'm going to include some of the more professional letters in this issue.

### The shorted in-situ tester

I wish I could print all of the funny letters I got about the dead short across the battery in the *in-situ tester* schematic. The schematic, as it originally appeared in the September issue, is shown in Figure 1.

Here is what happened. I just finished the article when I decided to make the drawing by Olszewski a little more clear. I got so busy straightening up the lines,

I didn't pay enough attention to the circuit. Olszewski's original drawing, showing the circuit as it should look, is in Figure 2.

Here is a letter from David A. Jenkins of Bennettsville, SC:

Sam:

Reading the September issue, got a good laugh when I hit page 60. Nice little circuit. Think I'll build one for myself. Will come in handy on my job (industrial electronics technician/electrician/hyp.). I'll probably leave out the DEAD SHORT across the batteries, though.

Mr. Jenkins also asked for a title or source for a good book on SCR dc drive

circuits, such as the ones on electric tow-motors, trolling motor drives, etc. Anyone have a suggestion?

David R. Nomi of Saratoga Springs, NY, sent this message:

Sir:

Refer to September '87 edition, page 60, Figure 1. It would seem that the ideal way to keep the battery manufacturers in business is to build in a permanent short circuit.

Here is one more letter on that subject from Ernest Buonpane of Queens, Long Island, NY:

Dear Sir:

On page 60 of the September issue,

Wilson is the electronics theory consultant for ES&T.

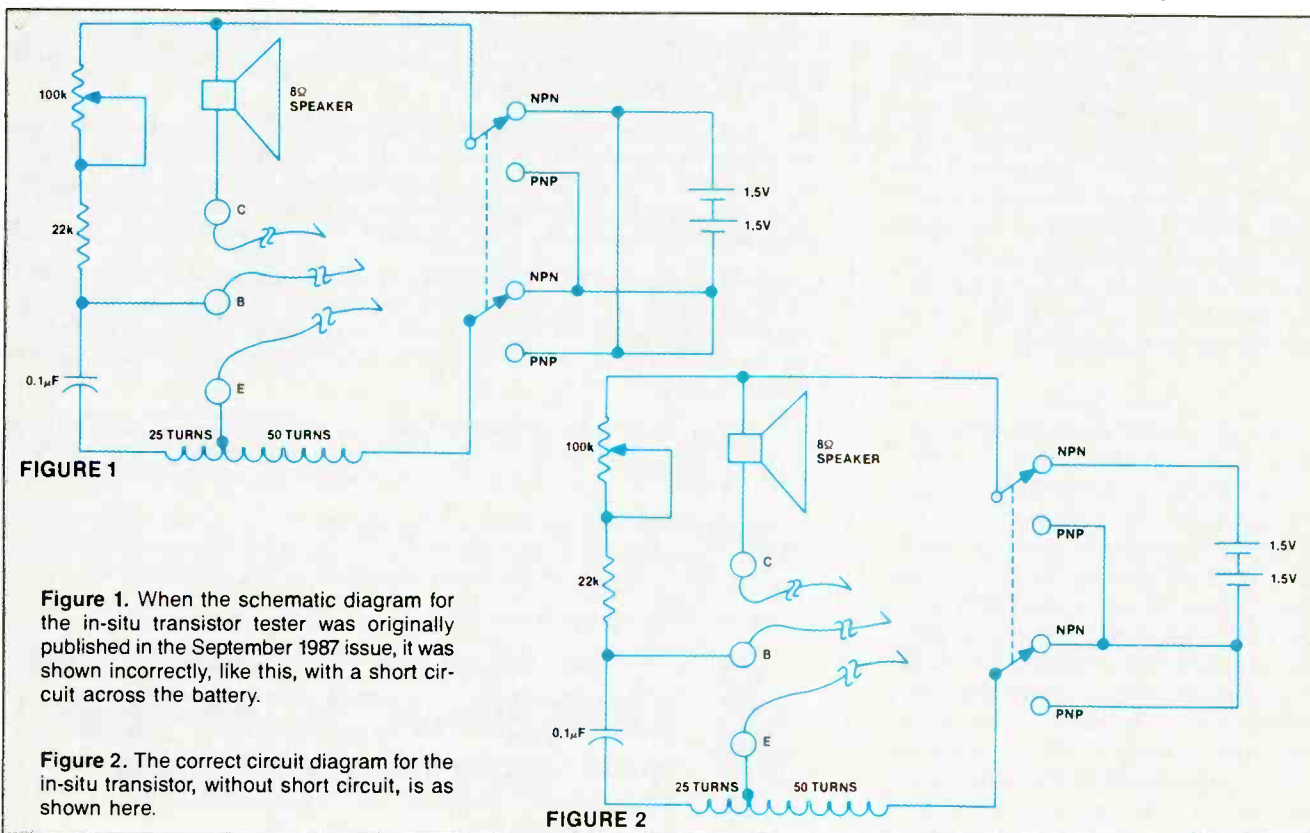



# The SC61 Waveform Analyzer™

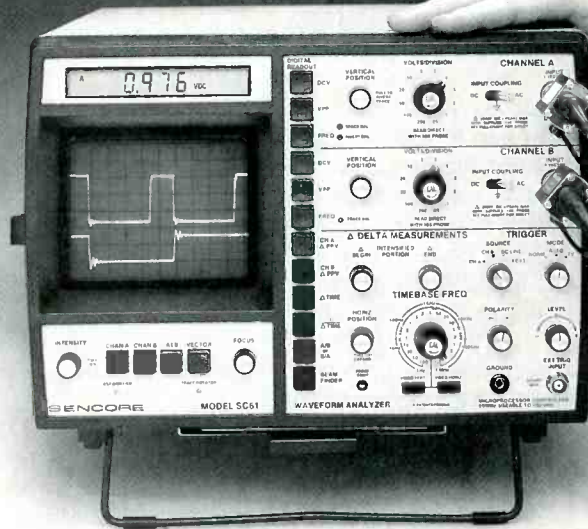

**\$3,295** Patented

## Here's what we say:

With just one probe hookup you can confidently analyze any waveform to 100 MHz, 10 times faster, 10 times more accurately, absolutely error-free — guaranteed or your money back.

## Here's what our customers say:

"The SC61 gives the most information with a minimum of probe-swapping and knob turning."

Patrick Lyman  
Biomedical Electronics  
Los Angeles, CA

"In my use of the SC61 Waveform Analyzer, it has reduced the amount of time in half in fixing communications equipment."

Jeff Williams  
Computer/Communications Repair  
Madison, TN

"We have a small shop and need all the short cuts, time saving equipment we can get. Sencore passes with flying colors. Every tech should try their techniques with the SC61 Waveform Analyzer. Does what it should and more."

Bill Humble, Jr.  
VCR, Audio and CB Repairs  
Yulee, FL

**Discover What The SC61 Waveform Analyzer  
Can Do For You! Call Today 1-800-843-3338.**

**In Canada Call 1-800-851-8866.**

100% American Made

# SENCORE

3200 Sencore Drive, Sioux Falls, SD 57107 605-339-0100 In SD Only

Circle (18) on Reply Card

January 1988 *Electronic Servicing & Technology* 57

you show a piece of do-it-yourself test equipment. I am very interested in building this in-situ transistor tester, but I don't understand why there is a jumper across the battery circuits, which I believe is short circuiting the batteries completely. I am anxious to build this circuit. Please let me know if I should make any changes in this circuit in order to correct it. Thank you.

I received the following letter from Keith A. Duke, a computer consultant and part-time instructor in West Palm Beach, FL. It shows how to use a calculator for decimal-to-hex conversion.

### Decimal to hex conversion

When converting a decimal number into its binary equivalent, it is usually more convenient to convert it first into hexadecimal notation. To convert a number into hex, keep dividing the number by 16 and note the remainder at each stage. The first remainder is the least significant digit. The remainder after the final division is the most significant digit. (Disregard the remainders in between.) For example, convert 745 (decimal) into hex using this traditional method:

$$\begin{aligned} 745/16 &= 46, \text{ remainder } 9 \\ 46/16 &= 2, \text{ remainder } 14 \\ 2/16 &= 0, \text{ remainder } 2 \end{aligned}$$

The hex digits for 745 (decimal) are 2, 14, 9, or 2E9 as they are normally written.

When I tried to teach this method to my students, they complained that their calculators did not generate remainders, so we devised a method that could be used on a calculator.

### The calculator method

Begin by generating the most significant hex digit: Repeatedly divide the

original number by 16 until the result is less than 16. The integer part of that result represents the first hex digit. Write that digit down, then subtract it from the displayed number to give a value whose integer part is zero. Multiply that value by 16; the integer part of the result represents the next hex digit. Repeat this procedure until you have multiplied by 16 as many times as you originally divided. At that point, the fraction part of the displayed number should be zero.

For example, using the calculator method to convert 745 to hex, you would get the following results:

**1st divide:**  
745/16 = 46.5625

**2nd divide:**  
/16 = 2.9101563

(1st hex digit is 2)  
-2 = 0.9101563

**1st multiply:**  
x16 = 14.5624  
(2nd hex digit is E14)  
-14 = 0.5625

**2nd multiply:**  
x16 = 9  
(3rd hex digit is 9)

The resultant hex number is 2E9, and its binary equivalent is:

0 0 1 0, 1 1 1 0, 1 0 0 1.

This technique works for quite large numbers, although repeated division by 16 can generate round-off errors. I found round-off errors at six digits. The final digit may appear as 2.996, in which case

read it as 3. It is essential to keep count of the number of divisions and make sure you have the same number of multiplications.

**One meter equals what?**

Michael B. Danish of Aberdeen Proving Ground, MD, caught a typo in the October issue.

Dear Sam:

You will probably get 100 or 1,000 letters on this one, but in the October issue, page 58, you say, "Note: 1m = 1,000cm." Of course, it should have read 1m = 100cm.

Your attempt at simplification is good, but this error (typo no doubt) will likely confuse the readers no end!

Michael Moran of Horicon, WI, likes the idea of home-brew equipment. He

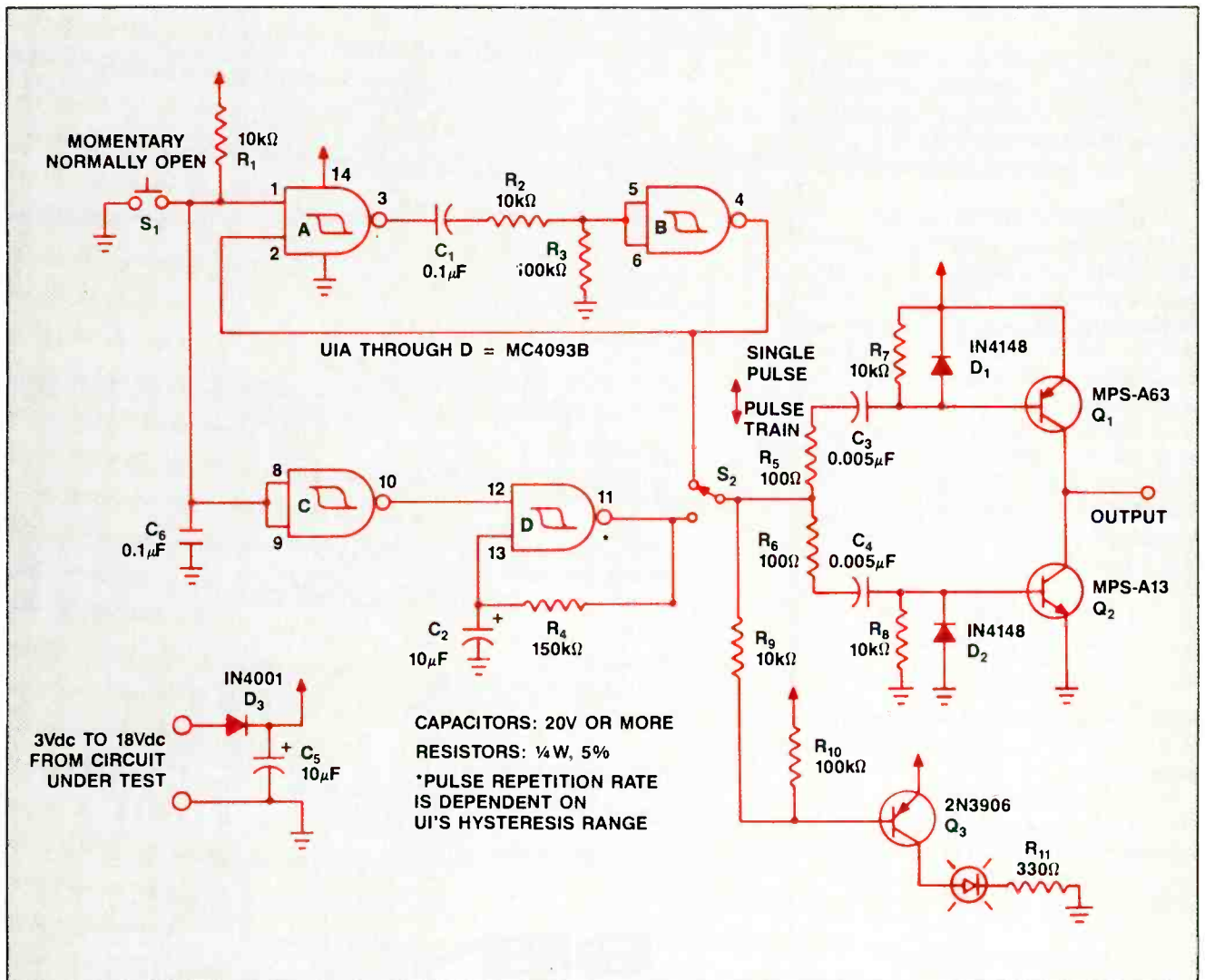

Figure 3. You can make your own logic pulser like the one shown in this schematic. See text for details.



sends a circuit to keep it going.

Dear Sam:

Your article in the September **ES&T** concerning home-brew test equipment sounds like a great idea for a continuing feature with reader contributions. Here's one of mine. (See Figure 3.)

UIA and B form a one-shot, which is triggered by pressing  $S_1$ . UID forms an oscillator with a frequency of approximately 3Hz. This oscillator is gated on by UIC when  $S_1$  is depressed.  $S_2$  selects either the one-shot pulse from UIB or the pulse train from UID for application to the output circuit.

The pulses appear at the junction of  $R_5$  and  $R_6$ . Positive going edges are coupled through  $R_6$  to the  $C_4$ - $R_8$  differentiating network, which causes  $Q_2$  to turn on and deliver a current-sink pulse of approximately  $10\mu s$ . The following negative going transition at  $R_5$ ,  $R_6$  causes  $Q_1$  to operate in the same manner, giving a  $10\mu s$  current-source pulse.  $D_1$  and  $D_2$  protect each transistor from possible base-emitter reverse overvoltage. When the circuit is not active ( $S_1$  open), both  $Q_1$  and  $Q_2$  are off and the output is in a high-impedance state similar to a "TriStated" logic gate.

Because the driving capability of a CMOS output is limited,  $Q_1$  and  $Q_2$  are Darlington's. I have been able to generate valid logic levels driving impedances as low as  $10\Omega$  between the pulser output and either supply rail, and I have pulsed both CMOS and TTL gates continuously for an hour without harming the driven chip.

$Q_3$  and the LED give a visual indication of pulse activity. One note is in order concerning the MC4093B: The component values shown for the oscillator and one-shot may have to be adjusted if a manufacturer other than Motorola is used. This is because the hysteresis range on the Schmidt is different due to each chip maker's process, and may even vary among chips in different production lots from the same manufacturer. In particular, the RCA version (CD4093BE) will run much slower as an oscillator.

The probe can be built into any convenient case. Mine is in a Global Specialties CTP1 case pirated from an old Radio Shack logic probe, with two switches wired in parallel for  $S_1$ , one on either edge of the case for convenient operation with either hand. **ES&T**

## Now test and restore every CRT on the market . . . without ever buying another adaptor socket or coming up embarrassingly short in front of your customer . . . or your money back



with the new improved CR70 "BEAM BUILDER"™  
Universal CRT Tester and Restorer  
\$1,295

### Have you ever?

**Thrown away a good TV CRT, data display CRT, or scope CRT** that could have been used for another two or three years because you had no way to test or restore it?

**Lost valuable customers** because you advised them that they needed a new CRT when another technician came along and restored the CRT for them?

**Lost the profitable extra \$35 or more** that you could have gotten for restoring a CRT while on the job and locked in the profitable CRT sale later?

**Avoided handling profitable trade-ins or rentals** because you were afraid you'd have to replace the picture tube when you could have restored it?

**Had a real need to test a CRT on the job**, but didn't have the right adaptor socket or setup information in your setup book?

If any of these things have happened to you, **CALL TODAY, WATS FREE, 1-800-843-3338**

WATS Free 1-800-843-3338 In Canada WATS Free 1-800-851-8866



# SENCORE

**Means Success In Electronic Servicing**

3200 Sencore Drive, Sioux Falls, South Dakota 57107

Call Collect 605-339-0100 in SD

Circle (19) on Reply Card

January 1988 *Electronic Servicing & Technology* 59

# Test your electronics knowledge

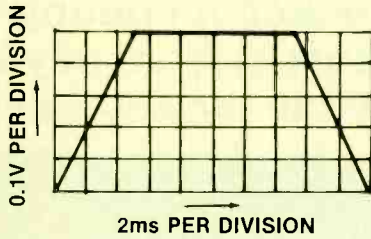

Figure 1. What is the rise time of this waveform?

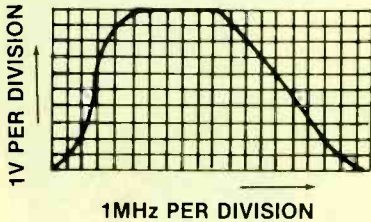
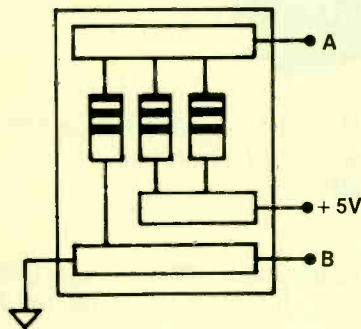

Figure 2. What is the bandwidth of an amplifier with this response curve?



ALL RESISTORS ARE  $470\Omega$

Figure 3. What is the voltage at point A with respect to the voltage at point B?

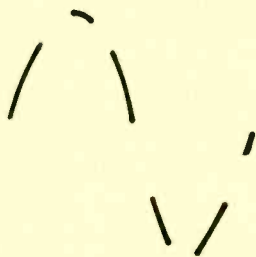

Figure 4. What inputs will cause this waveform on the scope?

By Sam Wilson, CET

In this issue, I have taken some questions from practice CET tests that I wrote for IS CET a few years ago. These practice tests are no longer being sold, but the questions still demonstrate important facets of technology.

- The rise time of the waveform in Figure 1
  - is 3ms.
  - is 4ms.
  - is 5ms.
  - cannot be determined from the information given.
- If bandwidth is defined as the range of frequencies between the

$\frac{1}{2}$ -power points, what is the bandwidth of an amplifier having the response curve shown in Figure 2?

- 20MHz
  - 17.5MHz
  - 10MHz
  - 2.5MHz
- Refer to Figure 3. What is the voltage at point A with respect to the voltage at point B?
    - 5.0V
    - 4.1V

Wilson is the electronics theory consultant for ES&T.

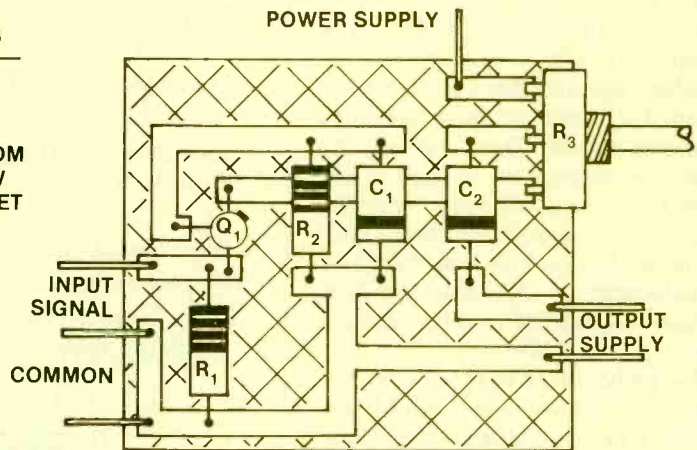
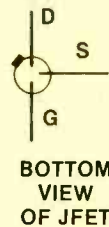

Figure 5. Can you answer questions 8 and 9 concerning this FET circuit?



## Ten Things You Can Do With The VA62 Universal Video Analyzing System — That You Can't Do With The Others.



**\$3,495** Patented

1. Quickly locate defective circuits by injecting signals without disconnecting components.
2. Replace video heads with confidence; a simple good/bad head test removes all doubt.
3. Align IF traps simply by just the pattern on the CRT — have the picture "looking like it did when they bought it."
4. Quickly align VCRs with special video patterns, or NTSC color bars. Meets all manufacturers' warranty requirements.
5. Performance test and troubleshoot any MTS stereo TV or VCR system, so you can cash in on new technology.
6. Confidently test deflection yokes, IHVTs, and flyback transformers, in-or out-of-circuit, before you replace them.
7. Add on phase-locked accessories into your video analyzing system to increase service potential as technology changes.
8. Performance test and troubleshoot digital/analog RGB video monitors, so you can test all of today's video systems.
9. Conquer tricky servo circuits in VCRs by injecting a reference 30 Hz servo pulse.
10. Cut your video servicing time in half . . . or your money back.

**Discover what the Universal Video Analyzing System can do for you! Call Today 1-800-843-3338.**

**In Canada Call 1-800-851-8866.**

100% American Made

# SENCORE

3200 Sencore Drive, Sioux Falls, SD 57107 605-339-0100 In SD Only

Circle (20) on Reply Card

January 1988 *Electronic Servicing & Technology* 61

C. 3.3V

D. 1.6V

4. Which of the following components is sometimes used as a parasitic suppressor?

A. Thermistor

B. Bead ledge

C. Ferrite bead

D. 4-layer diode

5. It is a common practice to locate thermistors and other measuring sensors in one leg of a Wheatstone bridge. The reason for doing this is that it

A. increases the sensitivity of the measurement.

B. makes the measurement nearly independent of power-supply voltage variations.

C. permits a maximum power transfer condition.

D. increases the circuit resistance, as seen by the sensor, to a greater degree.

6. A logic probe is not normally used for measuring a

A. pulse condition.

B. logic 1 condition.

C. logic 0 condition.

D. delay condition.

7. The oscilloscope display of Figure 4 is obtained by delivering signals to the vertical input and the

A. z-axis.

B. horizontal input.

C. external sync input.

D. external calibrate input.

8. Figure 5 shows an amplifier that uses an N-channel JFET ( $Q_0$ ). The power supply should be

A. positive with respect to common.

B. negative with respect to common.

9. In the circuit of Figure 5, gate bias is obtained with

A. a source resistor.

B. a power-supply voltage divider.

C. a resistor between the gate and drain.

D. (None of the above.)

10. Is the following statement true? *In a purely inductive circuit, no power is dissipated.*

A. False.

B. True.

Answers are on page 73

# Index of 1987 Articles

Compiled by Darren Sextro

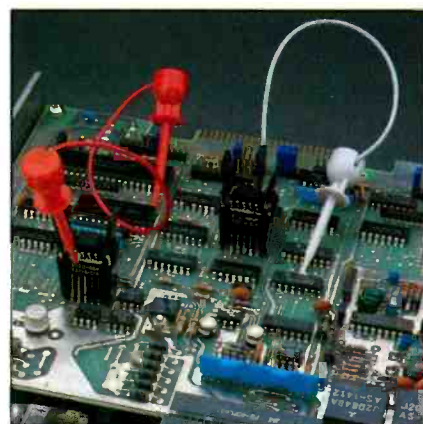
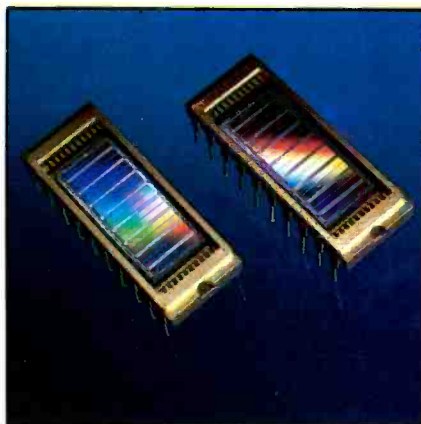
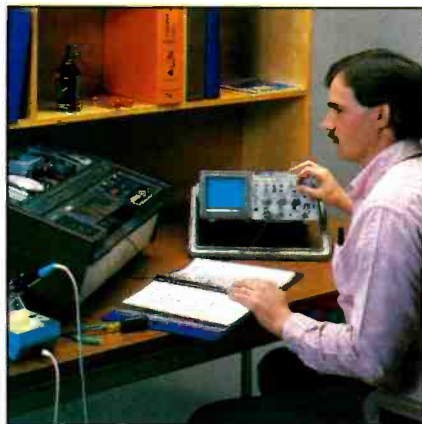

## ARTICLES

**AUTOMOBILE ELECTRONICS** Month Page  
New 4-wheel Steering Is Electronically Assisted... Jul...26

### CIRCUITS

Circuit Analysis and Troubleshooting Quiz!, by Bert Huneault... Jun...39  
What Do You Know About Electronics?—Circuits Used in Digital Audio Circuits, by Sam Wilson... Feb...52  
Computer-aided Circuit Design, by Howard Falk... Dec...40  
Don't Let Shutdown Circuits Shut You Down, by Gregory D. Carey... Sep...18  
What Do You Know About Electronics?—The Open Emitter Resistor, by Sam Wilson... Aug...48  
Test Accessories and Circuits, by Conrad Persson... Aug...23  
Troubleshooting Startup Circuits, by Gregory D. Carey... Nov...42  
Troubleshooting the Chopper Circuit, by Homer L. Davidson... Dec...20  
Unusual Waveform/Function Generator Circuits, by Joseph J. Carr... Oct...45

### COMPONENTS

Solid-state Rectifiers: Using, Abusing and Selecting, by Joseph J. Carr... Jul...18

### EQUIPMENT

Analog or Digital: Which DMM Is Best?, by Mike Hahn... Sep...10  
Choosing a Low-cost Oscilloscope, by Dave Herrington... Jan...18  
What Do You Know About Electronics?—Do-it-yourself Test Equipment, by Sam Wilson... Sep...60  
Locating Replacement Parts, by Conrad Persson... Dec...12  
Oscilloscope: The Eyes of the Technician, by Conrad Persson... Apr...10  
Report From the Test Lab: Model AR-460-D Hand-held LCR Meter... Apr...16  
Report From the Test Lab: The Dissipation Factor, an Explanation... Oct...10  
Report From the Test Lab: The Semianalyzer

Transistor/junction Tester... Nov...12  
Setting up a Test Bench, by Conrad Persson... Mar...59  
Test Equipment for Personal Computers, by Conrad Persson... Jul...12  
You Have to Buy Test Equipment OR DO YOU?, by Jack Cunningham... Jan...25

### MANUFACTURERS

Buyer's Guide 87, by the ES&T staff... Mar...13

### POWER CONDITIONING

Power Conditioning, by Conrad Persson... Nov...26

### REMOTE CONTROLS

What Do You Know About Electronics?—Infrared Remote Controls, by Sam Wilson... Apr...50  
What Do You Know About Electronics?—More on the Basics of Infrared Remote Controls, by Sam Wilson... May...46  
Tracking Down Remote Control Problems, by Conrad Persson... Dec...46

### SERVICING METHODS

Desoldering Components, Using Continuous Vacuum Solder Extraction, by James K. Bausell... May...12  
Disk Drive/Printer Servicing, by Conrad Persson... Feb...12  
Knob-repair Nightmare, by Larry Critchlow... May...52  
Learning From a TOUGH DOG TV Repair, by Max Goodstein... Apr...24  
What Do You Know About Electronics?—Living With Models, by Sam Wilson... Jun...52  
Locating and Replacing the Defective Flyback, by Homer L. Davidson... Jun...21  
Servicing Microwave Oven Panels, by Homer L. Davidson... Nov...18  
Troubleshooting Horizontal ICs, by Homer L. Davidson... Feb...17  
Troubleshooting Horizontal ICS, Part 2, by Homer L.



Davidson ..... Apr...43  
 Troubleshooting Low-voltage Regulators, by Homer L. Davidson ..... Jul...41  
 Using a Small Transformer to Get Special ac Voltages, By Arthur G. Hansen, PE ..... May...41  
 Using the Scope to Troubleshoot the Low-voltage dc Power Supply, by Joseph J. Carr ..... Aug...39  
 We All Know How to Solder, by Larry Critchlow... Aug...28

**SOUND**

Digital Audiotape Is on the Way, by Conrad Persson ..... Jun...46  
 What Do You Know About Electronics?—Digitizing Sound, by Sam Wilson ..... Jan...50  
 MTS: TV Sound in Stereo, Part 1, by Bert Huneault ..... Jan...44  
 MTS: TV Sound in Stereo, Part 2, by Bert Huneault ..... Feb...44

**STATIC**

Ruling Out Static, by Dixon Gleeson ..... Oct...26

**TESTING METHODS**

IC Tester, by Conrad Persson ..... Jun...11  
 The Meter Said...What?, by Joseph J. Carr ..... Nov...54  
 Testing Serial Communications With a Break-out Box, by Doug Swain ..... Feb...22

**TRAINING AND LITERATURE**

Technical Training and Literature Update, by Conrad Persson ..... Aug...15

**VCRs**

Maintenance and Cleaning of VCRs, by Victor Meeldijk ..... May...23  
 Measuring Tape Tension and Torque in VCRs, by Wayne Graham ..... Oct...42  
 VCR Test and Alignment Procedures, by G. McGinty ..... Oct...17

**DEPARTMENTS**

**BOOK REVIEWS**

	Month	Page
ABCs of Electronics, 4th edition, by Farl Jacob Waters	Oct	39
Books for electronic communication available from Microwave Filter Company	Jan	43
CD-I and Interactive Videodisc Technology, by Steve Lambert and Jane Sallis	Jul	56
Communications Electronics: Systems, Circuits and Devices, by Forest Barker	Nov	41
Complete Compact Disc Player, by Martin Clifford	Sep	57
Computer Electrical Power Requirements, by Mark Weller	Dec	53
Digital Logic Circuits: Tests and Analysis, by Robert G. Middleton	Feb	43
Electric Circuit Analysis, by S.A. Boctor	Feb	43
Electronic Connections, Home and Car Entertainment Systems, by Martin Clifford	Apr	60
Electronic Industry Telephone Directory (8th edition)	Sep	57
Electronic Principles: Integrated and Discrete, by James F. Cox and S. Roger Everett	Jul	56
Electronic Test Instruments: A User's Sourcebook,		

**Nine Test Probes with only one difference between them and your scope's original equipment**

Manufacturers Scope	Original Probe	Price	Coline/TPI Equivalent	Price
<b>TEKTRONIX</b>				
2300 Series	P6101A	\$53	M12X1	<b>\$38</b>
	P6108A	\$75	M12X10	<b>\$62</b>
2200 Series	P6121	\$100	M12X10AP	<b>\$68</b>
	P6122	\$58	P100	<b>\$38</b>
2400 Series	P6131	\$140	M15X10HFAP	<b>\$87</b>
	P6133	\$115	M12X10AP	<b>\$68</b>
400 Series	P6105A	\$93	M12X10AP	<b>\$68</b>
	P6106A	\$140	M15X10HFAP	<b>\$87</b>
	P6130	\$130	M12X10AP	<b>\$68</b>
<b>IWATSU</b>				
SS-5321	SS-0014	\$92	M12X10	<b>\$62</b>
SS-5711	SS-0012	\$77	M12X10	<b>\$62</b>
<b>LEADER</b>				
LBO-315	LP-060X	\$60	SP100	<b>\$43</b>
LBO-518	LP-100X	\$76	SP100	<b>\$43</b>
<b>PHILIPS</b>				
PM3267	PM8924	\$60	M12X1	<b>\$38</b>
& PM3256	PM8926	\$70	P100	<b>\$38</b>
PM3264	PM8928	\$95	M12X10	<b>\$62</b>
<b>HITACHI</b>				
V-1100A	} AT-10AL15	\$64	SP100	<b>\$43</b>
V-670				
V-509				
<b>HEWLETT PACKARD</b>				
1715A	10018A	\$135	M20X10	<b>\$68</b>
1722B	10017A	\$130	M15X10HF	<b>\$79</b>
1725A	10017A	\$130	M15X10HF	<b>\$79</b>
1740 Series	10041A	\$135	P100	<b>\$38</b>
	10021A	\$85	IP20	<b>\$29</b>

Take up the TPI challenge and compare our prices with the probes you currently use. In many cases you can replace both probes on your dual trace scope at the cost of one probe from the scope manufacturer. Plus, bandwidth and overall performance of the TPI probe typically exceed that of the original equipment. Satisfaction is guaranteed with a ten day return privilege. TPI Specialists in probes for over 15 years.

Available from your local distributor.

TOLL FREE INFORMATION LINE

1-800-368-5719,

1-800-643-8382 in California

**TEST PROBES, INC.** **TPI**

9178 Brown Deer Road,  
 San Diego CA, 92121  
 Phone: (619) 535 9292

Circle (21) on Reply Card

Sent to: 9178 Brown Deer Road, San Diego CA, 92121

Please send full line catalog

Name \_\_\_\_\_

Company \_\_\_\_\_

Address \_\_\_\_\_

Phone: \_\_\_\_\_



Month Page

by Robert Witte.....May...45

Electronics Math, by R. Jesse Phagan.....Apr...60

Elements of Electronic Instrumentation and Measurement, 2nd edition, by Joseph J. Carr.....Jul...56

Encapsulation of Electronic Devices and Components (Electrical Engineering and Electronics Series Volume 36), by Edward R. Salmon.....Oct...39

IC Functional Equivalence Guide (8th edition).....Sep...57

Illustrated Encyclopedic Dictionary of Electronics, 2nd edition, by John Douglas-Young.....Dec...53

It's YOUR Business, by William J. Lynott.....May...45

Operational Amplifiers and Linear Integrated Circuits, by Robert F. Coughlin and Frederick F. Driscoll.....Jun...45

Product Index, Underwriters Laboratories.....Nov...41

RS-232 Manual and Interfacing Guide, by Datatran.....May...45

Solid-State Projects You Can Build, by Rudolf F. Graf and George J. Whalen.....Jul...56

Standards Glossary, Underwriters Laboratories.....Nov...41

Troubleshooting and Repair of Microprocessor-Based Equipment, by John D. Lenk.....Jan...43

Troubleshooting and Repairing Solid-State TVs, by Homer L. Davidson.....Jun...45

Troubleshooting Techniques for Microprocessor-controlled Video Equipment, by Robert L. Goodman.....Jul...56

Understanding Electricity and Electronics Circuits, revised by David L. Heiserman.....Oct...39

Understanding Electricity and Electronics Principles,

Month Page

revised by David L. Heiserman.....Oct...39

VCR Troubleshooting & Repair Guide, by Robert C. Brenner.....Apr...60

**PROFAX**

GENERAL ELECTRIC	Profax Number	Month
CTC140 chassis, color TV.....	(3014)	Nov
MK-1 chassis, model 8-1938.....	(3008)	Jul
MK-1 chassis.....	(2099)	Feb
MK-2 chassis.....	(2097)	Jan
NF chassis update, color TV.....	(3003)	May
7-7130A chassis, 5-inch B&W.....	(3004)	May

**HITACHI**

CT1358 chassis, color TV.....	(3005)	Jun
CT2020W, CT2020B chassis.....	(3010)	Aug
CT2250B, CT2250W chassis.....	(3000)	Apr
CT2250B, CT2250W chassis.....	(3012)	Sep

**RCA**

CTC117-S2 color TV supplement.....	(2098)	Feb
CTC134 chassis, color TV.....	(3013)	Oct
CTC135 chassis, color TV.....	(3006)	Jun
VDM 140 chassis, color TV.....	(3002)	May

**ZENITH**

D2500W chassis, color TV.....	(3009)	Aug
D13085/D1910B chassis, color TV.....	(3007)	Jul
SD2501W chassis, color TV.....	(3011)	Sep

# WHEN A SURGE SUPPRESSOR IS NOT ENOUGH

## YOU NEED THE LINE STABILIZERS/CONDITIONERS FROM TRIPP LITE

The LC series are voltage regulators, protecting your equipment and data by maintaining a constant power level during voltage sags (brownouts). At the same time they provide complete ISOBAR® surge and noise suppression.



### COMPLETE BROWNOUT PROTECTION!

- 600, 1200 and 1800 watt models.
- Maintains load voltage at 120 AC ( $\pm 5\%$ ) from 96V AC to 138V AC input range.
- Indicator lights on LC-1800 monitor low and high voltage conditions.
- Prices starting at just \$119<sup>00</sup>.



EST 1922

“THE POWER PEOPLE”

500 N. Orleans • Chicago, IL 60610  
312-329-1777

Circle (45) on Reply Card



## SYMCURE

QUASAR	Month	Page
ADTS-976 chassis, extremely bright picture with retrace lines	Aug	30
ADTS-980 chassis, very little height	Aug	30
ADTS-980 chassis, picture has vertical-retrace lines	Aug	30
ADTS-980 chassis, top 1-inch to 2-inch of picture is missing; vertical linearity is very poor	Aug	30
ADTS-980 chassis, bright, smeared picture; sometimes "jail bars" on left side of screen	Aug	30
LDTS-989 chassis, 60Hz noise band in picture on VHF low-band channels	Aug	30

## SYLVANIA

E 32 chassis, left side of picture is darker, color smears	Feb	42
E 32 chassis, incorrect color hues	Feb	42
E 32 chassis, horizontal deflection does not operate	Feb	42
E 32 chassis, all color is missing	Feb	42
E 32 chassis, excessive brightness produces retrace lines	Feb	42
E 32 chassis, all sound is missing	Feb	42

## TECHNOLOGY

Advance in Chip Fabrication	Mar	10
Advanced CAD Reduces Design Time to Three Days	May	10

Month Page

Amplification of Feedback Item	Aug	10
Another First: The Experimental 4Mb CMOS DRAM	Apr	9
Automatic Focusing System Uses Video Signal	Jan	9
Digital Technology, Double Scanning, Clearer TV Pictures	Jun	7
High Performance LSIs Capable of Multiple-speaker Speech Recognition	Aug	10
High-resolution LCD	Dec	10
Jumbo Size Plus Sharp Resolution—All in One	Nov	11
Miniaturized, More Powerful Lasers Introduced	Jul	10
Total Remote Control	Oct	12

## TROUBLESHOOTING TIPS

### MAGNAVOX

T809 receiver, VHF channels will not tune	Jun	50
---	-----	----

### RCA

CTC71AB, sound but no raster	May	56
CTC97A chassis color receiver, intermittent height	Feb	41

### WARDS

GGV12934 color receiver, picture only 4-inch tall	May	56
---	-----	----

## AUDIO CORNER

Audio Equalizers	May	58
------------------	-----	----

## BOARD REPAIR DEPOT

### 1 YEAR GUARANTEE!

#### BOARD REPAIR:

Exceptional Quality & Reliability

\* Advance Exchanges Available

\* IBM PC, XT, AT

AT&T 6300

\* COMPAQ

EPSON

TI

#### TESTING:

100% Functional test

12 hour Burn-in @ 115°F

Outgoing final test and inspection

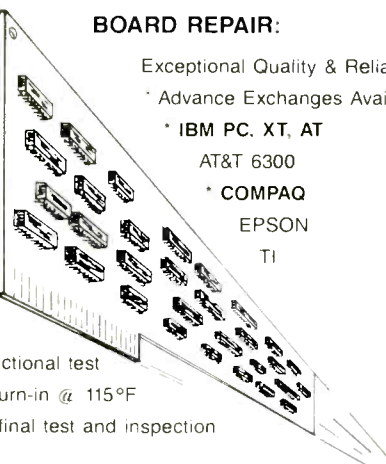

**1-800-BOARDFX**

*D. S. Walker & Associates, Inc.*

11210 Steeplecrest Suite #300 Houston, Texas 77065 (713) 890-2257

Circle (33) on Reply Card

## MCM ELECTRONICS

**Quality** is not an idle term at MCM! Every incoming shipment is checked and re-checked by our QC Department to see to it that you never receive a defective part.

**Service** is something you can always count on, too. Our experienced Sales Representatives and Electronic Technicians are standing by to take your orders and answer your questions quickly and courteously.

**Selection** helps us stand heads above the competition with nearly 10,000 in-stock items (including many hard-to-find products) that can be shipped to you immediately.

**Discover the MCM difference!** Order your copy of MCM's new Catalog today. It's a decision you'll never regret!



For your **FREE** copy, call **TOLL-FREE!**

**1-800-543-4330**

In Ohio, call

**1-800-762-4315**

In Alaska or Hawaii call

**1-800-858-1849**



**MCM ELECTRONICS**

858 E. CONGRESS PARK DR.  
CENTERVILLE, OH 45459

A **PREMIER** Company

SOURCE NO. ES-29

Circle (22) on Reply Card



Month Page

**COMPUTER CORNER**

Common Ailments of the Commodore 64..... May...60  
 Do It With Numbers..... Jun...60  
 If You're Just Starting to Service Computers..... Mar...70  
 Knowing the Parts of a Personal Computer..... Sep...68  
 More About Getting Started in Computer Repair... Apr...56  
 Read-only Memories..... Oct...60  
 Reading and Writing With PROMs..... Nov...62  
 RMMs: Erasable and Programmable..... Dec...60  
 Understanding Binary Coded Decimal (BCD)..... Aug...62  
 Understanding Computer Standards..... Feb...60  
 When Is a Computer Not a Computer?..... Jan...62  
 Working With Hexadecimal Numbers..... Jul...62

**VIDEO CORNER**

Adjusting the Tape Transport..... Dec...62  
 Advanced Electronics for Remote Control..... Nov...64  
 Azimuth Recording: The Way to Eliminate  
 Crosstalk Between VCR Video Tracks..... Apr...54  
 Coming Soon: Super VHS..... Aug...60  
 Diagnosing VCR Servo Problems..... Mar...72  
 Diagnostic Procedures for System and Servo  
 Control Circuits..... Feb...62  
 Just a Tape Recorder?..... Jan...60  
 Overall Block Diagram..... Jul...60  
 Some More Terms and What They Mean..... Jun...62  
 Some Terms and What They Mean..... May...62  
 Tuning VCRs With PLL and AFT Circuits..... Sep...64  
 VCR Mechanical-state Switch..... Oct...62



Month Page  
 Audio Servos..... Dec...64  
 Breaking the CLV Servo Loop..... Jul...64  
 Calibrating Test Instruments..... Feb...58  
 CD Player Servicing: Testing RF Amp and  
 Optics..... Apr...58  
 CD Sled and RF PLL Testing..... Aug...64  
 Component Interactions..... Oct...64  
 Hi-Fi Interference..... Jun...58  
 PLL Tuned FM Receivers..... Sep...66  
 Multichannel TV Sound (MTS)..... Jan...58  
 Using a Technical Help Line..... Nov...58  
 Whatever Happened to Controllable  
 Intermittents?..... Mar...68

**SPECIAL REPORT**

**SPECIAL REPORT**

**SPECIAL REPORT**

**SPECIAL REPORT**

**SPECIAL REPORT**

**SPECIAL REPORT**

**SPECIAL REPORT**

**SPECIAL REPORT**

**SPECIAL REPORT**

**SPECIAL REPORT**

**SPECIAL REPORT**

**SPECIAL REPORT**

**SPECIAL REPORT**

**SPECIAL REPORT**

# VCR SERVICING

All you need to know about  
servicing VCRs is in this  
exclusive report coming  
next month in:

**ELECTRONIC**  
*Servicing & Technology*



## Tool/test instrument catalog

*HMC* is offering a fully illustrated catalog of electronic tools, test equipment and supplies for the manufacture and repair of computer, telecommunication and electronic applications. The 98-page catalog covers test equipment, tool kits, soldering/desoldering systems, lamps and magnifiers, anti-static products, work stations, wire prep equipment and hand tools.

Circle (125) on Reply Card

## Replacement components catalog

*Amperex Electronic Corporation*, an affiliate of Philips ECG, has published the newly updated and expanded "ECG Semiconductors Master Replacement Guide." The guide lists almost 4,000 solid-state devices used as replacements for domestic and foreign types in entertainment, commercial and industrial equipment. The catalog includes 230 new types added to the ECG line.

The guide includes transistors; high-voltage rectifiers and triplers; small signal switching, zener and microwave diodes; rectifiers from 1A to 2,200A; SCRs and TRIACs; thyristors, over-voltage transient suppressors; bridges;

optoelectronic devices; linear and digital ICs, both commercial and industrial; peripherals and accessories.

Circle (126) on Reply Card

## Electronics catalog

*B&B Electronics* has announced its Catalog #10. The catalog features stock products as well as custom-designed electronic devices. Included are newly designed and manufactured 4-channel RS-232 to RS-422 converters, 8-channel RS-232 to RS-422 converters, a receive-only RS-422 to RS-232 converter, 10-mile short-haul modems, a serial-to-parallel converter, a 2-position scanning switch and a 2-position serial scanning switch.

Circle (127) on Reply Card

## Tool and accessory catalog

*Fordham's* new 164-page catalog includes approximately 2,000 illustrated items, with specifications and application data for each. Products shown include test instruments and accessories; CATV, CCTV and MATV equipment and accessories; tool uses, tools and assembly aids; replacement components; TV replacement parts and

antennas; and an assortment of consumer electronic and entertainment products.

Circle (128) on Reply Card

## Cleaner/burnisher catalog

*The Eraser Company* is offering an 8-page catalog describing its industrial cleaning and burnishing brushes. The catalog includes technical and application data. Included in the catalog are hand-held cleaning brushes, power-operated tools and a range of industrial brush kits for specific applications, such as cleaning gold finger-edge connectors and plastic mold cleaning.

Circle (129) on Reply Card

## Test equipment reference guide

A 350-page catalog from *Tucker Electronics* contains technical specifications and prices for more than 4,000 reconditioned test instruments and factory new instruments, power supplies, coaxial components, waveguides and waveguide components, and a line of technical books. Some items are current production models; others are hard-to-find, older models.

Circle (130) on Reply Card

## VCR Maintenance and Repair on Video Tape

There is no other tape like ours on the market. This VHS tape is loaded with one hour and forty-seven minutes of expert information. This new tape takes you step-by-step through four different VCRs and shows you the similarities and differences of each.

The only hand tool required is a Phillips head screwdriver. That's right! There is no test equipment or special tools required. Also, you need no special schooling to perform the simple tasks on our video.

### Save time and money

After viewing this program you will be able to do the most common repair jobs on all VCRs. To save time and money on your VCR repairs order your own VHS VCR tape NOW! Simply call:

(513) 548-6113 or

1-800-323-0826 (Ohio only)

and have your Master Card or Visa ready.

The tape is only \$29.95 + 3.00 (postage and handling). Please allow 6-8 weeks for delivery.

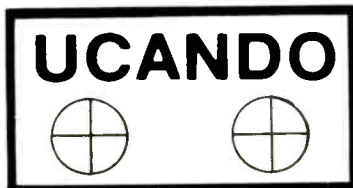

VCR EDUCATIONAL PRODUCTS  
P.O. BOX 386  
GREENVILLE, OHIO 45331

Circle (23) on Reply Card

## Your integrity is on the line.

### Monitron™ 2000

Don't let power line disturbances hang you up or threaten your professional integrity. The new Monitron 2000 power line monitor will increase your productivity and cost-effectiveness.

### MONITRON 2000 FEATURES:

- 5 fault detection levels: spike, high volt., low volt., dropout, power failure; self-test circuit
- ANSI standard trigger points
- Total compatibility
- Compact; mounts on terminal, peripheral or its own stand
- Easy to install & use

Contact: Mendon Electronics  
3800 Monroe Ave.  
Pittsford, NY 14534  
(716) 248-8480

Circle (24) on Reply Card

## ATTENTION! ELECTRONICS TECHNICIANS

EARN YOUR  
**B.S.E.E.  
DEGREE**

THROUGH HOME STUDY

Our New and Highly Effective Advanced-Placement Program for experienced Electronic Technicians grants credit for previous Schooling and Professional Experience, and can greatly reduce the time required to complete Program and reach graduation. No residence schooling required for qualified Electronic Technicians. Through this Special Program you can pull all of the loose ends of your electronics background together and earn your B.S.E.E. Degree. Upgrade your status and pay to the Engineering Level. Advance Rapidly! Many finish in 12 months or less. Students and graduates in all 50 States and throughout the World. Established Over 40 Years! Write for free Descriptive Literature.

**COOK'S INSTITUTE  
OF ELECTRONICS ENGINEERING**



4251 CYPRESS DRIVE  
JACKSON, MISSISSIPPI 39212

Circle (25) on Reply Card

## More on audio servos

By Kirk Vistain

Let's continue with the subject of servo motors in audio equipment. Where were we? Oh, yes, you'll remember that the servo system used a sawtooth generated by a dc voltage source. It can only be as precise as the voltage source, capacitors and semiconductor circuitry used to produce it.

Practically speaking, performance is quite good, but if you clip a few more hundredths of a percent off the flutter, you might bring the drift (speed variation over a long time period) down to 0.003%. (Remember when we were oblivious to 3%?) For those of you who may have forgotten, in the old days audio specifications functioned as sales tools, and improvements of a few thousandths of a percent also brightened the profit picture for a company.

Enter a circuit that since has become popular throughout audio and video—the phase-locked loop (PLL). Figure 1 represents a simplified version. Notice it has all the necessary elements of a ser-

vo: motor, feedback, reference, comparator and drive amp. This time, however, the reference source is an ac signal precisely generated by a stable crystal oscillator. The FG servo discussed last month sampled a ramp voltage with a square wave developed by motor feedback. This circuit directly compares two frequencies or, more precisely, their phase. The result is greater speed accuracy, both short (W&F) and long (drift) term. (By the way, the common advertising jargon for this setup is *quartz lock*, referring to the composition of the reference crystal.)

### Troubleshooting

Fixing these circuits is not much tougher than the FG servo. It just seems that way because the manufacturers often load up their top-of-the-line, quartz-locked units with a host of other features and, of course, a microcontroller or two.

Let's say the reference source fails. There may be any of several symptoms associated with this, because failure modes are handled differently from unit

to unit. It might not start, or it might run off-speed or backward. At any rate, you can check for an oscillation at a convenient low-impedance point, such as pin 3 of the IC in Figure 1, for example. You should see a healthy sine wave, with a peak-to-peak (p-p) amplitude close to  $V_{cc}$ . Make sure you're not loading the oscillator to death. Use the x10 setting on your scope probe.

If the signal is missing, you may have a bad crystal, capacitor, IC or something else that doesn't show on the schematic. You can use a little trick to isolate the bad part, however. There's usually an RF choke in the  $V_{cc}$  line for the PLL chip to keep the clock signal out of the power supply. Most times you can sub it for the crystal and get the oscillator to run, assuming only the crystal is bad. Of course, you must remember to put a jumper in the  $V_{cc}$  line to keep power supplied to the IC.

PLL circuits in audio servos tend to be highly reliable. Most problems are mechanical, as in any electromechanical device. I have even heard of a defective platter bearing causing intermittent loss of phase lock. Oddly, the bearing was not noisy.

Some units have what looks like a tape head that senses the flux of magnets built into the inside rim of the platter. This is necessary to produce an adequate FG signal with the slowly revolving rotor. The gap between the head and platter is sometimes quite critical. Too great, and intermittent speed lock occurs; too small, and runout causes mechanical interference, which may damage both head and platter.

### Direct-drive brushless motors

For better or worse, most quartz-locked phonographs also incorporate direct-drive motors—that is, the phono platter is the motor rotor. Compared to using a separate motor and belt drive, this scheme has several advantages: There's no belt to wear out; high-frequency rumble is eliminated; the mechanism has fewer moving parts; and speed control is more immediate. With belt drive, there is usually a slight lag between motor-speed correction and platter speed, thanks to the elasticity of the belt.

Unfortunately, there are a couple of disadvantages that are significant to the serious listener, but don't show up in the

Vistain is ES&T's audio consultant.

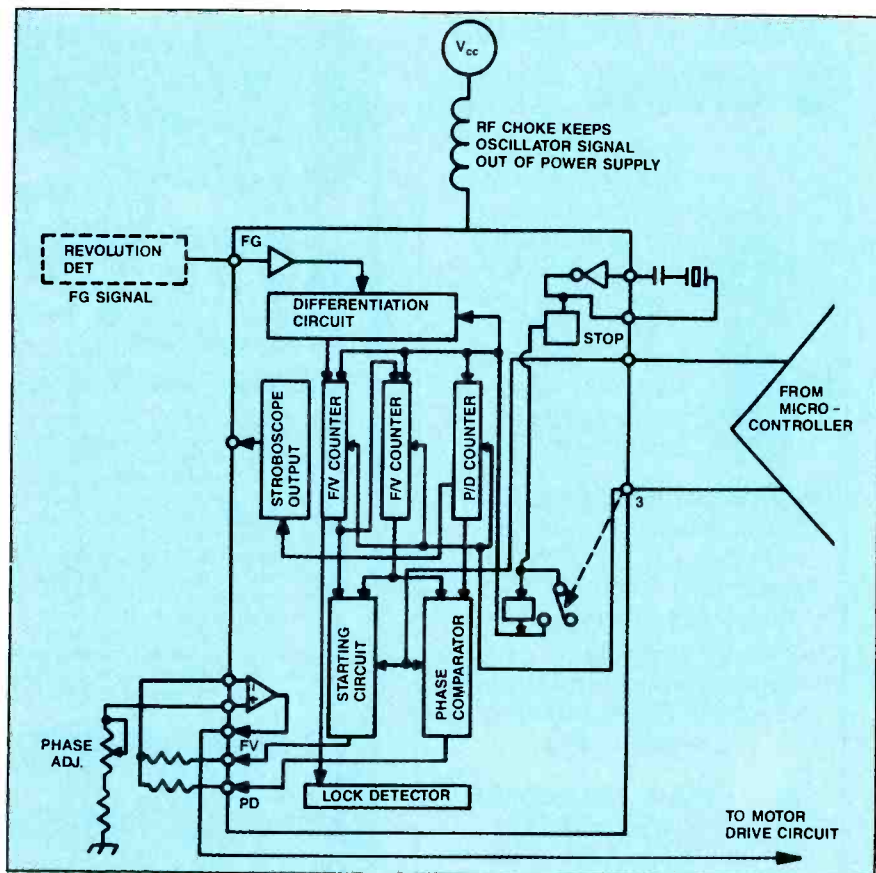

Figure 1. This simplified version of a PLL has all the necessary elements of a servo, but the reference source is an ac signal precisely generated by a stable crystal oscillator.



specifications. First of all, isolation suffers, resulting in more susceptibility to acoustic feedback. Second, direct drive tends to produce subsonic noise. Although it is inaudible to most of us, it interferes with some signal-processing circuits, such as the companders in hi-fi VCRs. Thanks to direct coupling and the excellent low-frequency response of modern audio amps, these subsonic signals often make it to the woofers, where they mix with the program material to produce undesirable artifacts.

### Theory

In order to directly drive a turntable platter, you have to get rid of the mechanically commutated motor that is common in belt-drive units and cassette decks. It can't be operated at speeds as low as 33rpm without a pulse-width modulation scheme that would certainly

semiconductor material, with current flow induced by a potential applied to the biasing electrodes. Another pair of contacts mounts to either end of the semiconductor, perpendicular to the electron flow. Because the slab is uniform, voltage is the same at both points. There is no output.

Now add a magnetic field at an angle to the movement of the charge carriers. The carriers no longer travel uniformly across the slab, but veer to one side. The resulting output voltage is proportional to biasing current and magnetic flux.

A ring magnet containing several poles (about eight), affixed to the bottom of the platter, rotates above the Hall devices. The varying outputs of the poles control the coil drive amps according to rotor position, causing it to rotate in the proper direction. (Figure 2 outlines the concept.)

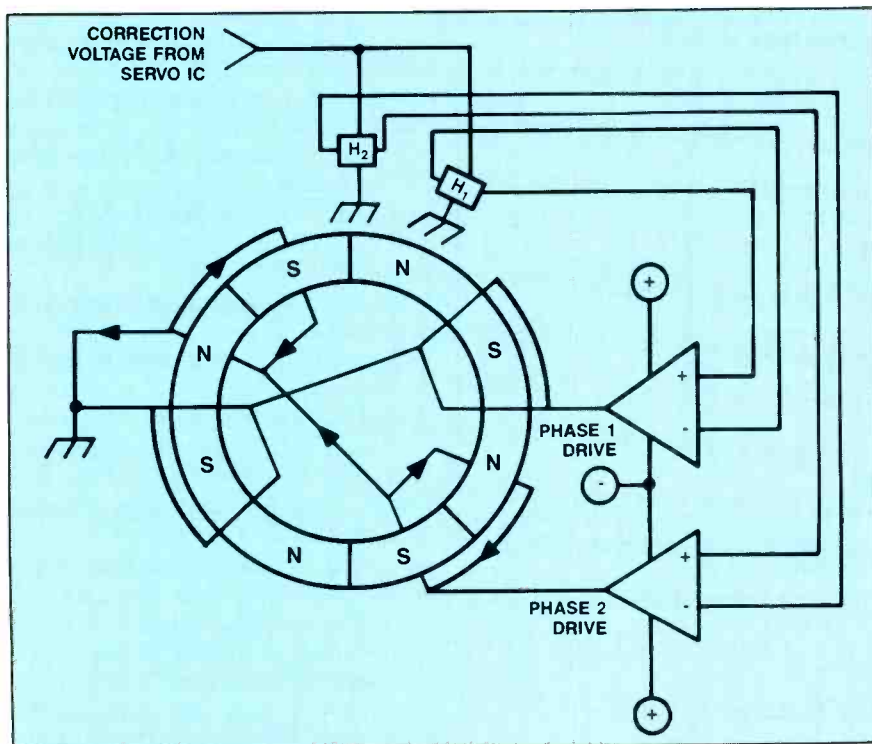

**Figure 2.** With direct drive, the platter rotates in the proper direction because of a ring magnet containing several poles. The poles' varying outputs control the coil drive amps according to rotor position.

ly lead to a high-flutter figure unless the platter were unreasonably heavy.

What we need is an electronic analog of the commutator. Key to its operation are the two small blocks labeled H<sub>1</sub> and H<sub>2</sub>. These are Hall effect devices. Each has four electrodes—two for biasing, two for output.

Imagine a uniform rectangular slab of

Once you know that the power supply is OK, don't automatically condemn the motor. It's important to check whether some external control voltage from elsewhere in the circuitry is disabling the drive. You may be able to check the drive coils for continuity, but testing the Hall devices without damaging them is tricky.

**BS&T**

**REDUCE  
YOUR COSTS...  
INCREASE  
YOUR  
PROFITS...**

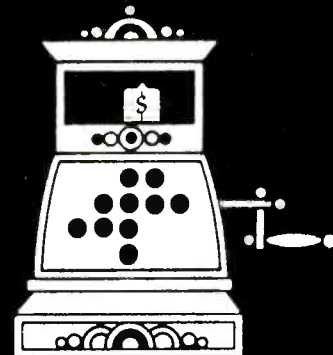

**WITH THE PRB  
BELT SYSTEM**

**PROJECTOR-RECORDER BELT** offers you the world's most complete inventory of replacement belts for all types of electronic equipment including...

- VIDEO RECORDERS
- COMPUTER PERIPHERALS
- TURNTABLES
- CASSETTE RECORDERS
- PROJECTORS
- 8-TRACKS
- 145 VIDEO BELT KITS

PRB has the replacement belt you need in just the right shape and size. **PLUS** the PRB system helps you find your replacement belt easily and fast for maximum convenience that assures profitable returns.

**PRB...THE SOURCE FOR  
OVER 10,000 ELECTRONIC  
COMPONENTS**

We stock a wide variety of electronic components. These are all high quality electronic components at everyday low prices backed by service you can depend on.

For details on our profitable belt system and a **FREE** copy of our Catalog just write or call toll free...

NATIONAL 1-800-558-9572  
IN WISCONSIN 1-800-242-9553  
BUSINESS NUMBER 1-414/473-2151  
IN CANADA CALL COLLECT: 1-613/225-5003  
TLX 4994411 PRB USA FAX: 414/473-4727

**PROJECTOR-  
RECORDER  
BELT  
CORPORATION**

P.O. Box 176 Whitewater, WI 53190

Circle (26) on Reply Card

## Accessing read-only memories

By Bert Huneault

This is the last part of a 4-part series on non-volatile memories. Part one covered the basic read-only memory (ROM). Part two discussed program-

mable memory (PROM) and erasable PROMs. Part three covered read-mostly memory (RMM), which is electricaly erasable and programmable.

Although the four types of ROMs differ in how they are programmed and whether they can be reprogrammed, they all share some basic similarities when it comes to reading and writing, or *accessing*, the memory. In the examples shown here, each has 10 or 11 address lines and eight data pins. The number of power-supply inputs and enable pins determines the size and type of memory.

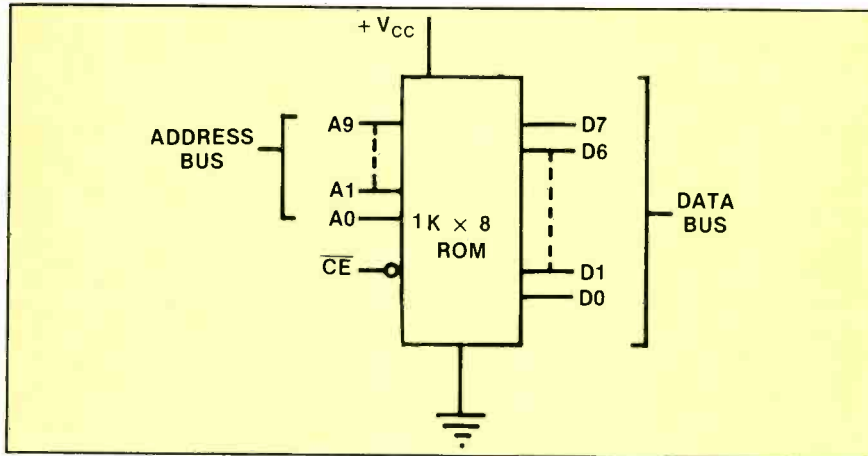

Figure 1. With only one enable pin ( $\overline{CE}$ , chip enable), the ordinary ROM can be read from but not written to. Ten address lines gives it a 1Kbyte memory.

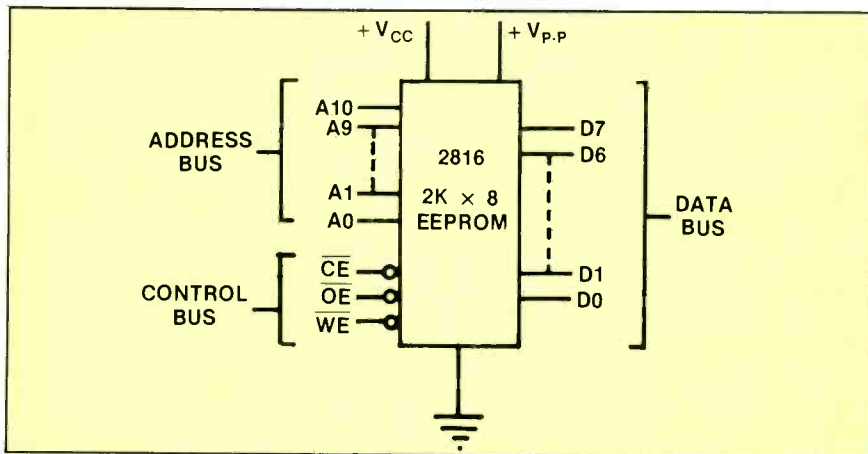

Figure 2. The EPROM has two enable pins ( $\overline{CE}$  and  $\overline{OE}$ , or output enable) and two power-supply inputs, which allows data to be written to memory.

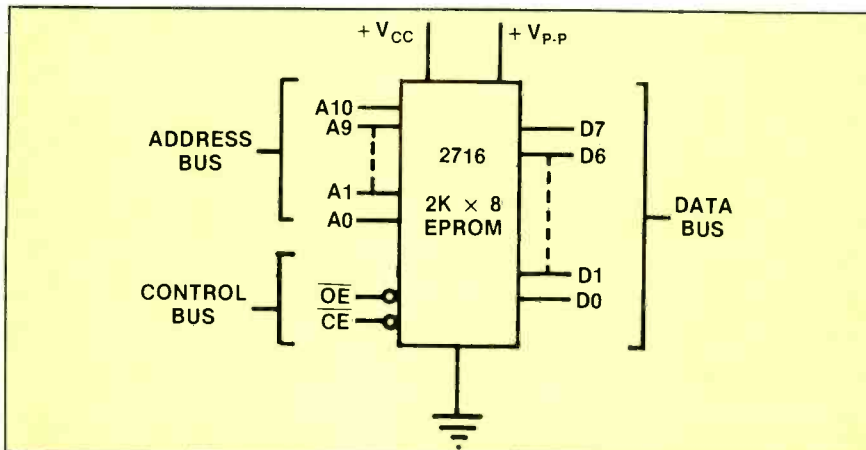

Figure 3. Three control lines ( $\overline{CE}$ ,  $\overline{OE}$  and  $\overline{WE}$ , or write enable) make several combinations of control logic, including single-byte erasure, possible for the EPROM.

### Reading from ROMs

Because ordinary ROMs can be read from but not written to, accessing this type of memory is very simple. Figure 1 is a diagram of a 1K x 8 ROM. This chip can store 1,024 data words because it features 10 address lines, A9 through A0 ( $2^{10} = 1,024$ ). The data words are eight bits wide (byte size) because of the IC's eight data pins (D7 through D0).

$\overline{CE}$  (chip enable) is an active-low control input, as indicated by the overbar as well as by the bubble at the chip's  $\overline{CE}$  input. Therefore, the  $\overline{CE}$  line must go low to enable the chip, causing a read operation. Some manufacturers refer to  $\overline{CE}$  as  $\overline{CS}$  (chip select) or  $\overline{OE}$  (output enable).

To read the information contained at a particular location in the ROM, the address (10-bit pattern) must be placed on the address bus; the  $\overline{CE}$  input is then forced low (grounded) for a moment. This causes the data stored at the specified address to be output via the IC's output pins (D7 through D0). The data then travels along the databus to a microprocessor, peripheral device or whatever. Typical access time for such a read operation is on the order of a few dozen nanoseconds in bipolar ROMs.

When  $\overline{CE}$  returns to the high state, the chip's outputs are disabled—the eight output lines return to the high-impedance state, effectively disconnecting the ROM from the databus.

### Readin' and writin'

Accessing EPROMs is a little different, because you can write to and read from an EPROM. Figure 2 is a diagram of a commercially available EPROM, type number 2716. With 11 address lines and eight data lines, it has a capacity of 2,048 8-bit words ( $2^{11} = 2,048$ ); in other words, it can store 2kbytes.



Note that the EPROM has *two* power-supply inputs,  $V_{cc}$  and  $V_{pp}$ , and *two* control inputs,  $\overline{OE}$  and  $\overline{CE}$  (both active-low).  $\overline{OE}$  controls the output buffers and determines whether EPROM data appears on the data lines.

To read data stored in the EPROM, the following conditions must be met:

- $V_{cc}$  and  $V_{pp}$  terminals must both be connected to +5V.
- The address must be input via the address pins.
- $\overline{CE}$  must go low.
- $\overline{OE}$  must go low to enable the output buffers in the chip, allowing the stored data byte to be output on the data pins.

For a programming operation (to write new data into any one of the memory's 2,048 address locations), the EPROM must have been erased with UV light to render it clean. Then:

- $V_{cc}$  must be connected to +5V.
- $V_{pp}$  must be connected to +25V.
- The address must be applied to the ad-

dress pins.

- The 8-bit data word must be applied to the data pins.
- $\overline{OE}$  must be high (+5V) to convert the data pins into inputs rather than outputs.
- A 50ms positive pulse (+5V) must be applied to the  $\overline{CE}$  control pin. By the time this pulse ends and  $\overline{CE}$  returns to the low state, the selected address location will be storing the applied data byte.

#### Erasing one byte at a time

Accessing an EEPROM is quite similar to reading from or writing to an EPROM; of course, the EEPROM is electrically erasable rather than UV erasable. Figure 3 shows a type 2816 EEPROM, which is compatible with the 2716 EPROM.

Note that the EEPROM has an extra control pin:  $\overline{WE}$  (active-low write enable). With *three* control lines, several

combinations of control logic are possible, each one resulting in a different mode of operation. For example, for a read operation,  $\overline{CE}$  and  $\overline{OE}$  must be low, and  $\overline{WE}$  must be high. To write a byte into a specified address,  $\overline{CE}$  and  $\overline{WE}$  must be low, and  $\overline{OE}$  must be high. To place the chip's data lines in the high-impedance state,  $\overline{CE}$  must be low, and both  $\overline{OE}$  and  $\overline{WE}$  must be high. Other combinations of control-bus logic are used for *byte-erase* and *chip-erase* operations. The chip-erase mode has the same effect on the EEPROM as ultraviolet erasure has on an EPROM.

Although we've come a long way since the days of magnetic core memories—today's solid-state memories are nothing short of phenomenal in terms of capacity and speed—the future undoubtedly has much more in store.

Huneault is an electronics instructor and head of the REE department at St. Clair College of Applied Arts & Technology.

**ES&T**



## ESR METER

**CHECKS ELECTROLYTICS  
IN-CIRCUIT  
WITH 99% RELIABILITY**

A great time-saver that's been tested by 3 magazines and thousands of satisfied customers since 1978.

Ideal for preventive maintenance: measures electrolyte dryness & shows up intermittent opens.

60-day Satisfaction Guarantee

Send check or M.O. or call  
(313) 435-8916 for COD

Or write for free brochure to:

*Creative Electronics*

ESR Brochure  
1417 N. Selfridge  
Clawson, Mich. 48017

**\$149.00**  
postpaid  
USA & CAN

Circle (27) on Reply Card

Technicians,  
Get Serious  
About Your  
Profession



Being a certified electronics technician lets people know that you are a professional in your field. It tells them that you are serious about your work and can perform up to CET standards.

Now you can order the "Study Guide for the Associate-Level CET Test" from the International Society of Certified Electronics Technicians. It includes material covering the most often missed questions on the Associate CET exam. 8 1/2" x 11", paperback, 60 pages.

For More Information Contact:

IS CET, 2708 W. Berry, Fort Worth, TX  
76109; (817) 921-9101

NAME \_\_\_\_\_  
ADDRESS \_\_\_\_\_  
CITY \_\_\_\_\_ STATE \_\_\_\_\_  
ZIP \_\_\_\_\_  
\_\_\_\_\_ copies @ \$5 (+ \$1 postage.)  
\_\_\_\_\_ send material about IS CET  
and becoming certified.



## FREE CATALOG SERVICE TOOLS & TEST INSTRUMENTS

Packed with over 5,000 quality products for testing, repairing, and assembling electronic equipment. A full selection of test instruments, power protection equipment, precision hand tools, tool kits, soldering supplies, and much more. Products are shown in full color with detailed descriptions and pricing. All products come with a 100% satisfaction guarantee. SAME-DAY shipment program.

In a hurry to receive your catalog?

Call (800)-225-5370

In Massachusetts call (617)-682-2000

Contact East, Inc., Dept. R415  
P.O. Box 786, No. Andover, Ma 01845

Circle (28) on Reply Card

## The Newvicon pickup tube

By Conrad Persson

Home video has become so popular and affordable that more and more households are equipped with not only VCRs, but with video cameras as well. In order to understand the theory of operation for a video camera, it is essential to understand the operation of the pickup tube. One of the frequently used pickup tubes in consumer video cameras is the Newvicon tube. The theory of operation of this device, adapted from the 1984 GE Technical Training Manual for VCRs and Video Cameras, follows. (See Figure 1 for a cutaway drawing.)

Conventional electromagnetic focus/deflection pickup tube systems use external focus coils that form electronic lenses in the pickup tube, allowing the dc current to flow in the coils so that the beams are focused on the target. However, the new electrostatic focus system uses internal electrodes to focus the beams on the target, thus reducing power consumption. (Figure 2.)

The electronic beam is accelerated by

Persson is editor of ES&T.

G2, then passes through the beam-limiting aperture in order to generate fine-diameter beams. These beams are then focused by the electrostatic lens, composed of G3, G4 and G5. Grids G5 and G6 form a collimating lens, through which the beams are deflected so that they always hit the target at the proper 90° angle. This improves the resolution around the edges of the pickup tube.

The lens, located in front of the pickup tube, gathers the light from the scene and focuses it onto the face of the pickup tube. There, a photoconductive layer creates a large number of individual target elements. These elements are made up of electrostatic capacitance paralleled by light-dependent resistance, forming an RC time constant. (See Figure 3.)

The electrostatic capacitance is basically formed between the glass faceplate and the back surface, where the photoconductive layer acts as a dielectric. The target elements are all connected on one end to the signal electrode. The other end is unterminated and ready to receive the beam.

When there is no light striking the faceplate of the pickup tube, the light-dependent resistors create a high resistance. Whenever light hits the face of the target area, the resistance drops; the level depends on the amount or intensity of the light.

When a positive voltage is applied to the target, all the RC networks or elements charge as the beam first scans the target area.

When the beam is not in contact with the target element, the capacitance will slowly discharge through the light-dependent resistor connected across it. Keep in mind that each element's resistance will vary depending on the light level. On subsequent scans of the beam, the capacitors will recharge back to the target potential. It is this charging current that is sensed to produce the video signal. When the beam scans the target, electrons are deposited on the positively charged areas, which will return them to the negative potential of the cathode. This produces current, which flows through the external signal-developing resistor RL (Figure 4).

ES&T

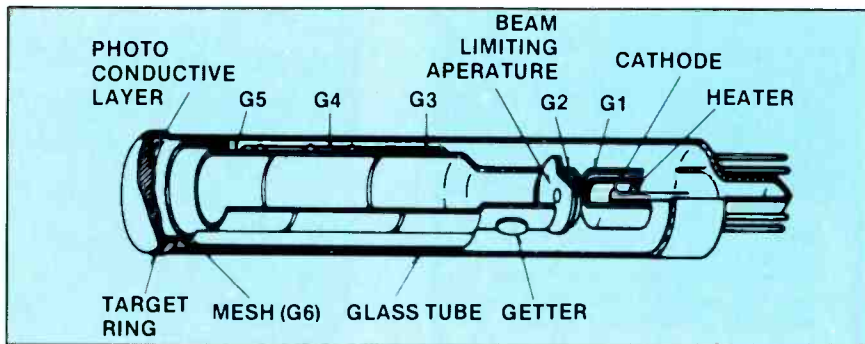

Figure 1. Cutaway drawing of the Newvicon tube.

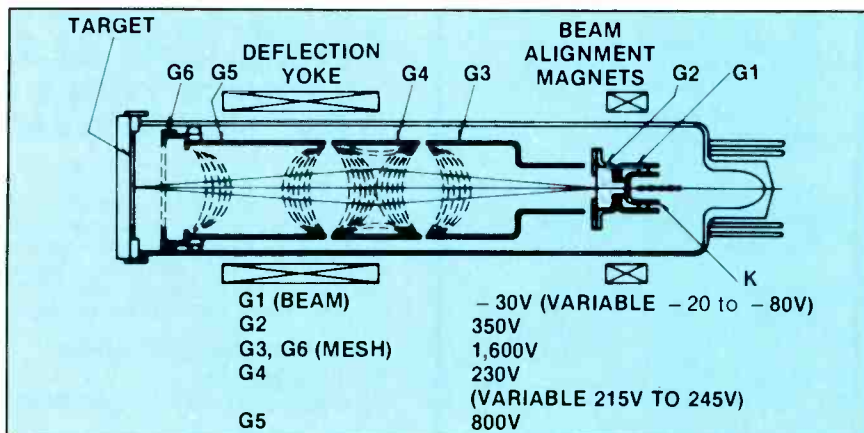

Figure 2. The electrostatic focus system uses internal electrodes to focus the beams on the target, reducing power consumption.

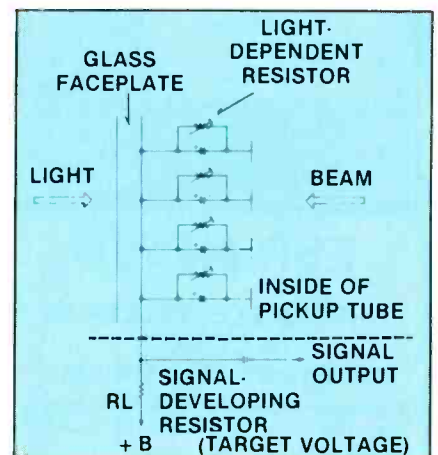

Figure 3. The target area of the pickup tube.

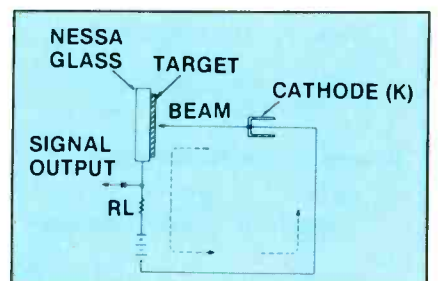

Figure 4. The electron path causes a current to be produced; this changing current is the converted optical image.



## Quiz answers

Questions are on page 60

1. B. 4ms. Rise time is measured from the point where the curve is 10% of maximum to the point where the curve is 90% of maximum. Note that maximum is 0.5V, so the 10% point is one-half of the first vertical division.
2. C. 10MHz. Note that the vertical axis is marked in volts rather than power, so the 1/2-power points have nothing to do with this problem. Bandwidth is also taken between points that are 0.707 times the maximum voltage.
3. C. 3.3V. There is a series-parallel circuit between the +5V terminal and common. It can be redrawn as in Figure 6. The voltage can be found using voltage divider calculations as follows:  

$$V = 5 (470/705) = 3.33V$$
4. C. Parasitic oscillations can damage circuit components. The ferrite bead acts as an inductor that offers a high impedance to parasitic oscillation frequencies.
5. B. The Wheatstone bridge circuit is composed of resistors, and they do not have the capability to increase the sensitivity of the measurement.
6. D. A delay condition. The logic probe does measure the other three conditions.
7. A. The z-axis intensity modulates the beam. In other words, it turns the beam off and on, which explains why only parts of the waveform appear.
8. A. Positive. Note that the *top view* of  $Q_1$  is shown on the board. The drain (at the top) gets its positive voltage through  $R_3$ .
9. A. The source resistor is  $R_1$ . Note that it is connected directly between the source and circuit common. Because the input signal is across this resistor and the gate is common (because of the presence of  $C_1$ ), it follows that  $Q_1$  is a common gate amplifier.
10. B. True. There is no power dissipated in purely inductive and purely capacitive circuits. Of course, they exist only in theoretical problems. In the real world, both have resistance.

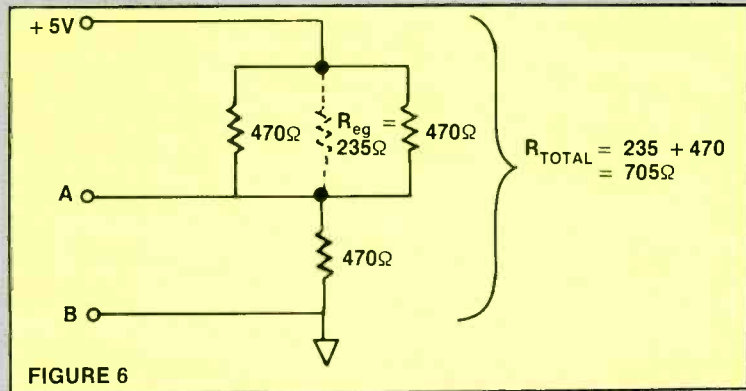

# Learn how-to repair:

## VCRs CDs Computers TVs

# ...and more

Subscribe to  
**ELECTRONIC**  
*Servicing & Technology*  
magazine

# Readers' Exchange

**Editor's note:** Readers' Exchange items are published in the order they are received. We are happy to offer this service at no charge to you, our readers, but ask that:

- Items are legibly written or typed.
- Your name and address are included on the same page as your item (envelopes and contents often become separated). Phone numbers also may be included. Using your peel-off label is a good idea.
- You limit any item to no more than three units.

Please understand that **ES&T** is in production six weeks to two months *ahead* of publication date.

## Wanted

Heath model 0-1 oscilloscope in exchange for an excellent 5MC triggered scope. *Louis Strauss, 5114 Miembro, Laguna Hills, CA 92653.*

Service/operator's manual for Simpson model 479 TV-FM signal generator. Will pay copying and mailing costs. *Bill Haxmeier, 89 S. Algona St., Dubuque, IA 52001; 319-556-6622.*

GE flyback EP77X21 or FLY606. GE TV CH# 17YA. Send price. *John J. Augustine, Augustine's TV & Radio Service, 530 N. 9th St., Reading, PA 19604; 215-372-5438.*

Bushing and pinch-wheel adapter kit #3876 15ips for Roberts tape recorder model 1720. Will con-

sider complete recorder with 15ips adapter. *Jesse L. Pruitt, RD. 1 Box 37P, Hop Bottom, PA 18824; 717-289-4376.*

RCA factory service manuals: color TV 1973, 1974, 1981-present. *Calvin S. Logue Jr., 17 J Washington Lane, Westminster, MD 21157; 301-857-5745.*

Lectro Tech manuals for models SMG-39 sweep marker generator and TO-50 oscilloscope. *W. Stegmiller, P.O. Box 2025, Butler, PA 16003; 412-285-1338.*

Garrard SL95 turntable, counterbalance weight and locking screw; Telechron electric clock 8B07, parts. *James Vandemark, Box 3472, Santa Rosa, CA 95402.*

Parts for cable converters, mainly microprocessors, for: G.I. LCC-58/Jerrold 400, Jerrold 450 & Universal V-1000 compatible with Radio Shack. Also need converter schematics. *Dan Ritter, Southside Electronics, 26 E. Cumberland St., Allentown, PA 18103; 215-797-9638.*

Remote control for Sylvania (CX0178WR) AWG80 superset. Must be reasonable. *J. Schmidt, 53330 Nadine, South Bend, IN 46637.*

Old oscilloscopes for parts; service information for Signal Corp. model BC-348 R receiver. *Dave Dvorak, Rt. #4 Box 175, Richland Center, WI 53581; 608-647-4844 or 608-647-8713.*

Picture tube for model 470 Hickok oscilloscope,

believe picture tube no. is 5UP1. *Larry Cook, 362 E. South, Richland Center, WI 53581; 608-647-4678.*

3NF and 2HF tubes for Loewe radio receiver (1927); 3KP4 CRT; AK breadboard parts; Sodian receiver and tubes made by Conn Telephone & Electric Co. *Dan Steele, 205 High St., San Luis Obispo, CA 93401; 805-544-2904.*

ES&T magazines, June-Dec. 1976. *C.L. Auer-nheimer, ALC, 4561 E. Florence Ave., Fresno, CA 93725.*

Service literature and schematics for Coleco-ADAM Family Computer System: keyboard 2404-BK, expansion module #3, display DM30-09BO-241-C42, printer 41021. *Luis Pena, P.O. Box 954, Montevideo, Uruguay, South America.*

Knight 83YX137 AF generator, with manual; 83Y135 signal tracer manual; and 83YX123 sweep generator manual. *C.T. Huth, 229 Melmore St., Tiffin, OH 44883; 419-448-0007.*

SAMS CB manuals. Send list and price. *Leon Hennes, Lakeside Comm., Box 842, Riverdale, ND 58565.*

Horizontal oscillator IC #56A24-1 or 56D24-1 for Admiral model 25CG31 TV, or info on where to find one. *H. Sievers, 6819 Willamette Drive, Austin, TX 78723; 512-926-7479.*

Panasonic WV-033P camera and NV-8000 VTR

## When You Want the Best Buy the Best



When your problems require the attention of a professional, call NU DATA, the company that originated the "Break-Out-Box" 17 years ago. The Model 921-T3 is the only battery free breakout with pulse trap.

- Dual LED Tri-State Design
- Battery Free Operation
- Guaranteed for Life
- GSA Approved

\$176.00

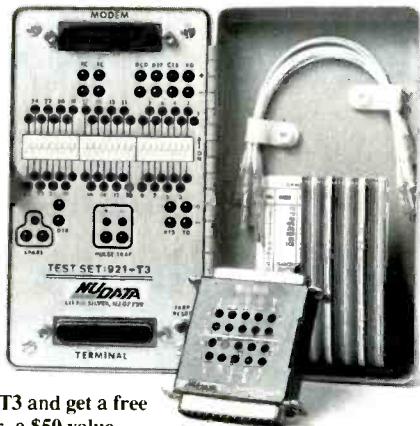

\*Buy a Model 921-T3 and get a free Interface Monitor, a \$50 value.

Call for information on our complete line of testers.  
(201) 842-5757

**NU DATA**

32 Fairview Avenue  
Little Silver, NJ 07739-1515

Circle (29) on Reply Card

## "ES&T is always great."

### "Especially Troubleshooting Tips and Profax are extremely helpful. Keep them coming."

Tony Bernler, Owner  
Tony's TV Service  
St. Croix, VI

# ELECTRONIC

Servicing & Technology

Practical techniques for today's servicing professional



service data. Gary Woods, SLE Electronics, R.R. 2, Box 589, Delanson, NY 12053; 518-875-6531.

Hickok CB signal generator and test unit. Must be in perfect working condition. Charles H. Handley, Handley's Radio & TV Service, 212 Dorchester Ave., Cambridge, MD 21613.

Radio News pre 1950. Radio (and TV) Retailing Magazines, any issues. Radio Call Book Magazine pre 1930. Any old radio advertising items, small indoor lighted signs, displays, etc. Lawrence Solow, 16 Sleepy Hollow Road, Saddle River, NJ 07458; 212-975-1776.

## For Sale

Service manual for TEAC model A-4010S reel-to-reel tape deck. Larry's Island TV, 2244-C Periwinkle Way, Sanibel, FL 33957; 813-472-4100.

RCA model 10J106 color test jig with many RCA and Zenith adapters and manual, \$85; B&K model 466 CRT tester and rejuvenator, \$50. Dennis Dillon, 1616 S. 94th St., West Allis, WI 53214; 414-774-2255.

Heath 10-14 5-inch scope with schematic and all manuals, looks and works like new, \$125; B&K Analyst 1077B, like new, all leads and manual, in original carton, \$195; VIZ WP-27A isolation transformer, like new, \$75. Paul's TV, 260 Main Cross, Charlestown, IN 47111; 812-256-3119.

Beltron picture tube restorer, model 2972-E, has five meters, \$50; Heathkit regulated HV power supply, model IP-17, no manual, \$50; B&K tube tester, model 747-B, like new, in carton, \$200. Kenneth Miller, 10027 Calvin St., Pittsburgh, PA 15235; 412-242-4701.

Admiral HV transformer (FLY504) focus divider, rectifier and cup (socket). For model 18T131, chassis 7K1885-1; \$25 including shipping. Calvin S. Logue Jr., 17J Washington Lane, Westminster, MD 21157; 301-857-5745.

Vacuum tubes: TV, radio, amateur radio. Send request list. J. Schmidt, 53330 Nadine, South Bend, IN 46637.

B&K TV analyst, model 1077B, with leads and manual, good condition, \$225. E.F. Meade, 502 1/2 1st Ave., West Logan, WV 25601; 304-752-0010.

RCA 10J106 color TV test jig, new, for PR-57 or B&K 1655 isolation transformer power supply. For sale or trade. James E. Gregorich, 117 2nd St. N., Virginia, MN 55792; 218-749-4355.

Sencore LC53 Z-meter with manual and test leads, excellent condition, never exposed to outside environment, \$625 (includes shipping and insurance). Call 412-694-2700, noon until midnight EST, Mon. through Fri. Sam Jacobs, Derry Electronics, 511 W. Fourth Ave., Derry, PA 15627.

B&K 415 sweep/marker generator with manual, leads and probes, like new, \$125 plus shipping; Heathkit FM stereo generator model IG-37 with

manual and leads, \$20 plus shipping. J.R. Chaves, 9768 Michaels Way, Ellicott City, MD 21043.

Test equipment. 19 pieces. Example: Southwest Technical Product 0-32Vdc regulated power supply, 2A, w/meters, \$95; Heath IR-5204 strip chart recorder w/extra paper, \$250; Sencore CR31A CRT tester and rejuvenator w/extra sockets, \$595. All excellent condition, shipping extra. Send for complete list. David Knapp, Dave's Northwoods Electronics, P.O. Box 159, Lac Du Flambeau, WI 54538; 715-588-3674.

SAMS photofact volume 1-1489, make offer. Gene Tyra, Norsworthy Music Center, 1814 Main St., Vernon, TX 76384; 817-552-2321.

UREI audio spectrum analyzer model 100-A with calb.; AKG #C451E microphone, all aluminum case, mint condition; \$350 plus shipping. Dave Rygwalski, 2100 So. Beech Road, West Palm Beach, FL 33409.

Sound Tech 1000A/M2 FM generator plus #110 freq. convert., \$600; H-P 333A distortion analyzer, auto-null, and H-P 5221A/01 counter, 1MHz, both for \$500. Plus shipping. J.S. Jasper, 21404 Shannon Ct., Cupertino, CA 95014; 408-252-1117.

B&K model 162 transistor/FET tester, \$70, in mint condition, with batteries, test cables and instruction manual. Tests in circuit or out. Will ship UPS collect. C.A. Caputo, 7 Donna St., Peabody, MA 01960; 617-535-1091.

**ESU**

**TV TOUGH DOGS:** 300 symptoms and cures. Send \$7.95 to DAVIS TV, 11772 Old Fashion Way, Garden Grove, CA 92640. 10-87-tfn

**SONY-TRINITRON** Rebuilt Picture Tubes are now available. All tubes shipped U.P.S. No Charge. We buy all Sony duds. Rochester Kinescope. 716-235-0750. 11-87-tfn

**PHOTOFACTS:** Individual folders #1 to #1400 \$3.00. Above #1400 \$5.00. Sent same day first-class postpaid. Loeb, 414 Chestnut Lane, East Meadow, NY 11554. 12-87-6t

**TV TROUBLESHOOTING:** 130 Problems-Solutions plus 12 steps to easier repairs. \$12.00. Remarkable Diagnostic tool, measure high voltage performance, no mistakes, \$5.00. Jones, Box 702, Niceville, FL 32578. 11-87-3t

**CABLE TV** We carry a full line including units for Tocom and Pioneer. Tocom turn-ons, technically correct, recordable, auto sensing. Units for Video Tape Copyguard from \$59.95. Deluxe Electronics 1432 Heim, Orange, CA 92665 (714) 998-6866. 01-88-3t

**FOR SALE:** New gov't surplus isolation transformers. Dual voltage primary 110/220 volts. Secondary is tapped at 105, 110, 115 volts. Shipping weight 17 pounds. (48 states only) Output rating 500 VA. \$12.50 plus UPS fee for 17# to: L.F.C. 105-A South Balt. St., Franklinton, Pa. 17323. 01-88-1t

**FOR SALE:** T.V. Tuners & Flybacks. Send S.A.S.E. for list. Also have R.C.P. Flybacker, Flyback & Yoke tester \$35.00 will trade for test equipment. (617) 259-8377. 01-88-1t

**TV/VCR "TUFF TIPS"** listed by mfg. and model. 1st edition—200 TV/VCR tips \$10.95, 2nd edition—200 TV/VCR tips \$10.95, both editions \$19.95. For TV tips only—1st or 2nd edition, \$5.95, both editions \$10.95. For VCR tips only—1st or 2nd edition, \$6.95, both editions \$12.95. TECH CURES, 4825 Fredericksburg Road, San Antonio, TX 78229. 01-88-2t

**TV/VCR FAILURE HISTORIES**—Multiple cures for most problem areas. Send \$6.95 with mfg. and model number to TECH CURES, 4825 Fredericksburg Road, San Antonio, Texas 78229. Money will be refunded with free sample, if model is not on database. 01-88-2t

**VCR CROSS-REFERENCE** listing for the following electronically-similar manufacturers: RCA, GE, Sony, Panasonic, Quasar, Magnavox, Philco and J.C. Penney. Send \$13.95 to TECH CURES, 4825 Fredericksburg Road, San Antonio, Texas 78229. 01-88-2t

**CRT MANUFACTURER** will rebuild your color picture tube for \$65.00. New electron gun, 2 year warranty, 25VEUP22, 25VFCP22, and other 100 degree types. Send your duds & \$65.00 money order for fastest service to: CRT Sales, 1314 Hamilton Ave., Cleveland, Ohio 44114. Phone (216) 431-4608. 01-88-2t

**ELECTRODYNE** is rebuilding the world of electronics. Tuner Rebuilding: 24-hr. turnaround, one year limited warranty. TVRO Equipment Repair: 72-hr. turnaround, 90-day limited warranty. VCR Repair: 72-hr. turnaround, 90-day limited warranty. VCR RF Modulators & A/B Switch Repair: 24-hr. turnaround, 90-day limited warranty. Module Repair: 72-hr. turnaround, one year limited warranty (See price list for exceptions). Most makes and models. Electrodyne, Inc., 917 S. Rogers St., Bloomington, IN 47401 (812) 334-1023. 01-88-3t

**PHOTOFACTS:** CB, TSM, AR, and TR Series books. \$3.50 each. Blankinship TV, 1216 N. Main, Rusk, TX 75785 214-683-5070. 01-88-3t

**ALL HAVE ORIGINAL CARTONS** and come with their manuals, Sencore VA62 \$3300, includes 50k probe, 10k probe and cover. VC63 \$400, NT64 \$400, LC76 \$1300, SCR 250 \$150, CR70 \$1000, Leader O scope LB0524 \$950, Isotop II \$110, Global freq counter \$170, Tentle TQ600 \$140, HPG-1 with stand \$480, T2 H7 UMC \$295, TSH B3 \$395, TSH V4 \$395. Hi-Tech VCR & TV Servicing, 6477 Ludlum Road, Morrow, OH 45152. 01-88-1t

## WANTED

**WANTED:** Hand controller cables for Intellivision Video Games. Part #2609-9579. Ken Johnson, Video Game Service, 244 Blaine Ave., Racine, WI 53405; 414-637-5019. 01-88-1t

## Classified

Advertising rates in the Classified Section are \$1.55 per word, each insertion, and must be accompanied by payment to insure publication.

Each initial or abbreviation counts a full word.

Minimum classified charge \$30.00.

For ads on which replies are sent to us for forwarding (blind ads), there is an additional charge of \$35.00 per insertion to cover department number, processing of replies, and mailing costs.

Classified columns are not open to advertising of any products regularly produced by manufacturers unless used and no longer owned by the manufacturer of distributor.

## FOR SALE

**AUTOMOBILE RADIO** and tape replacement parts. Delco, Chrysler, Philco-Ford, Motorola, Panasonic and many others. Large inventory. Laran Electronics, Inc., 3768 Boston Road, Bronx, NY 10469. (212) 881-9600. National (800) 223-8314, NY State (800) 446-4430. 1-85-tfn

**VCR REPAIR SOLUTIONS FOR VHS MODELS.** Volume 1-150 Symptoms and cures-\$11.95. Volume 2-\$11.95. All 300, \$19.95. Eagle Electronics, 52053 Locks Lane, Granger, IN 46530. 12-87-6t

**SERVICE MANUALS.** Large Shop has 18 yr. collection of duplicates. All original manufacturer. All new. Audio \$1.00, video \$5.00. Send SASE for list. Tape Recorder Clinic, 4850 E. Speedway, Tucson, Arizona 85712. 11-86-tfn

## BUSINESS OPPORTUNITIES

**TV/VCR SALES & SERVICE;** well established, fully equipped. Located in northern Virginia, highest growth area in U.S. Retiring because of health reasons. Call 703-972-7027 after 7:00 PM EST. 12-87-tfn

**BOCA RATON, FLA.,** 10 miles north of Ft. Lauderdale. One man Zenith Service Shop established 20 yrs—4000 satisfied customers—Grossing 40,000 plus—All Parts, Five Zenith Jigs and Service Vehicle—Ready to Go—\$25,000. Call (305) 425-4815 01-88-1t

**SHAMROCK TV REPAIR (ETC)** in warm San Diego. Established twenty years. Choice location. Retiring. Call (619) 488-8282 res (619) 222-4652. 01-88-1t

### TV "TECH'S" DREAM

TEST & RESTORE EVERY CRT on the market.... without every buying another adaptor socket for your CRT tester. Fits ALL makes & models. MONEY BACK GUARANTEE. Over 12,000 sold. Complete Patented Kit, with Sockets & Setup Book.... Only \$63.95 ppd. A one-time investment for life!! Visa/MC/COD's/Checks.

**FREE CALL 1-800-331-9658**

**DANDY MFG. CO.**

**2323 Gibson Street Muskogee, OK 74403**

Circle (30) on Reply Card



**"Tech's Guide To Pricing"**  
updated new 5th edition...a framework for setting rates that apply to Hi-Tech products...a formula that guarantees SUCCESS!  
Call Toll Free for details **1-800-228-4338** 8/5 CST

Circle (32) on Reply Card



**HAND REMOTE REPAIR**  
**LA GUARDIA ENT.**  
5882 Rich Hill Way  
Yorba Linda, CA 92686  
(714) 579-1276

- Call for pricing
- 24 hr. turnaround time
- Return freight pre-paid

90 Day Warranty New Battery Included

Circle (31) on Reply Card

### IN OUR CONTINUING EFFORTS TO SERVE YOU...

From time to time, Intertec Publishing Corp. makes its subscriber lists available to carefully screened companies or organizations whose products, services, or information may be of interest to you. In every case, list users must submit their promotional material for approval. They may use the list only once.

No information other than name and address is ever divulged, although names may be selected by segments to which the particular offer might appeal.

We are confident that the majority of our readers appreciate this controlled use of mailing lists. A few people may prefer their names not be used.

If you wish to have your name removed from any lists that we make available to others, please send your request, together with your mailing address label to:

**Direct Mail Mgr.**  
**Intertec Publishing Corp.**  
**P.O. Box 12901**  
**Overland Park, KS 66212**

# Ad Index/Hotline

Company	Page Number	Reader Service Number	Advertiser Hotline
Amprobe Instruments	11	7	516/593-5600
Beckman Industrial Corp.	IFC	1	619/495-3200
Becktron	20	11	800/592-4141
C 1/2 S Sales	13	14	800/292-7711
Chemtronics, Inc.	1	3	800/645-5244
Contact East	71	28	800/225-5370
Convex	45-46	44	703/661-8900
Cooks Inst. Elec. Engrg.	67	25	601/371-1351
Creative Electronics	71	27	313/435-8916
D.A.T.A., Inc.	31-32	35	800/854-7030
Dandy Mfg. Co.	76	30	800/331-9658
Electronics Book Club	21	12	
Fluke, John Mfg. Co., Inc.	5	5	800/227-3800
Hitachi Sales Corp. of America	27	15	516/921-7200
Iscet	71		817/921-9101
Jensen Tools Inc.	45-46	43	602/968-6231
Laguardia Enterprises	76	31	714/579-1276
Leader Instrument Corp.	3,33-34	4,37	514/337-9500
MCM Electronics	65	22	800/543-4330
Mendon Electronics	67	24	716/248-8480
NRI Schools-Electronics Division	31-32		202/244-1600
Nu Data Corp.	74	29	201/842-5757
OK Industries, Inc.	7,31-32,43-44	8,36,42,47-51	800/523-0667
Parts Express Int'l Inc.	25	16	513/222-0173
Prentice-Hall Inc.	33-34	38	
Projector Recorder Belt Corp.	69	26	800/558-9572
Sencore, Inc.	55,57,59,61	17,18,19,20	800/843-3338
Sperry Tech, Inc.	76	32	800/228-4338
Tab Books	43-44	40	800/233-1128
Techni-Tool	43-44	41	215/825-4990
Tektronix, Inc.	8A-8B,9,23	6,13	800/433-2323
Tentel	33-34	39	800/538-6894
Test Probes, Inc.	63	21	619/535-9292
Tripp Lite (Div. of Trippe Manufacturing Co.)	64	45	312/329-1777
U.S. Instrument Rentals	19	10	800/824-2873
U-Can-Do VCR Educational Products Co.	67	23	513/548-6113
Vu-Data Corporation	18	9	619/452-7670
Walker, D.S. & Associates	65	33	713/890-2257
Windsor Technologies, Inc.	IBC	2	415/456-2200
Zenith		BC	

## Use ES&T classified ads

**ELECTRONIC SERVICING & TECHNOLOGY** Volume 8, No. 1 (USPS 462-050) is published monthly by Intertec Publishing Corp., 9221 Quivira Road, P.O. Box 12901, Overland Park, KS 66212. Second Class Postage paid at Shawnee Mission, KS, and additional mailing offices. POSTMASTER: Send address changes to ELECTRONIC SERVICING & TECHNOLOGY, P.O. Box 12952, Overland Park, KS 66212-9981.

### ADVERTISING SALES OFFICES

## ELECTRONIC

*Servicing & Technology*

#### ALL U.S. TERRITORIES

*Greg Garrison, Sales Manager*

P.O. Box 12901

Overland Park, KS 66212

Phone: (913) 888-4664

Fax: (913) 888-7243

Telex: 42-4156 INTERTEC OLPK

#### NORWOOD, AUSTRALIA

*Hastwell, Williamson, Rouse PTY. LTD.*

P.O. Box 419

Norwood, S.A. 5067

Phone: 332-3322

Telex AA 87113

#### OXFORD, ENGLAND

*Nicholas McGeachin*

Roseleigh House, New Street

Deddington, Oxford OX5 4SP

Phone: (0869) 38794

Telefax: (0869) 38040

Telex: 837469 BES G

#### TOKYO, JAPAN

*Haruki Hirayama,*

EMS, Inc.

Sagami Bldg., 4-2-21, Shinjuku,

Shinjuku-ku, Tokyo 160, Japan

(03) 350-5666

Telex: 2322520 EMSINCJ

Code: EMSINCPERIOD



# DIAGNOSTICS

## for Personal Computers from Windsor Technologies

Windsor Technologies offers a family of diagnostic products for IBM PC, PC XT, PC AT and compatible computers. Originally designed for and used by service industry professionals, Windsor's products are well suited for anyone involved in the management and maintenance of personal computers.

### PC-Technician™

#### Professional Level Personal Computer Diagnostic System

PC-Technician is an 'advanced' type diskette-based diagnostic system that provides comprehensive testing for each individual system component. Information about the testing and the results are presented via text and graphics on the system's display. PC-Technician provides on-line help displays and information about the system's configuration.

PC-Technician is ideal for service personnel, manufacturers, OEM's, and users who need detailed information about the status of their computer's hardware.

PC-Technician is available in the following configurations:

- Product Code T01 (for PC, PC XT) **\$195.00**
- Product Code T51 (for PC AT) **\$245.00**
- Product Code T90 (for PC, PC XT, PC AT —  
T01 and T51 in the same carrying case) **\$395.00**

A FREE Evaluation Diskette is available—see the coupon below.



T90—PC, PC XT, PC AT

### WindsorPOST™

#### Personal Computer Diagnostic ROM Module

WindsorPOST is designed to be used when the system is malfunctioning such that its 'power-on-self-test' (commonly called POST) does not complete satisfactorily and a diskette-based diagnostic product, such as PC-Technician, cannot be loaded and used for troubleshooting.

WindsorPOST temporarily replaces the system's BIOS ROM module. When installed, its LED indicates if the proper amount of power is at the BIOS ROM socket. It then performs 36 tests on the circuits and electrical components on the system board, the system memory up to 640K, and the color or monochrome video display memory. Errors are identified down to the module (chip) level in three full displays of information on the system's video display unit.

WindsorPOST is intended for those service operations where specific identification of failing components is required and where soldered components are removed and replaced. WindsorPOST has been in use in the field for over one year and performance data indicates that it properly identifies the failing component at least 70% of the time.

WindsorPOST is currently available for use on IBM PC's and PC XT's (a PC AT type product is under development) and those compatible systems where the system board circuitry and components are extremely similar to the IBM standard. WindsorPOST comes with a 30-day money back guarantee.

- Product Code P01 (PC, PC XT) **\$295.00**



P01—PC, PC XT

For immediate ordering, contact Windsor Technologies at (415) 456-2209, 8:30 AM-5:00 PM Pacific Coast time. VISA, Mastercard, American Express and COD orders accepted.



Volume discounts and reseller discounts are available.

### Windsor Technologies, Inc.

130 Alto Street  
San Rafael, CA 94901  
(415) 456-2200

PC-Technician and WindsorPOST are trademarks of Windsor Technologies, Inc., and IBM PC, PC XT, PC AT are trademarks of International Business Machines Corporation.

### Windsor Technologies, Inc.

130 Alto Street, San Rafael, CA 94901 · (415) 456-2200

Please Send A Free PC-Technician Evaluation Diskette

Please Send Info About PC-Technician  WindsorPOST

NAME \_\_\_\_\_ TITLE \_\_\_\_\_

COMPANY \_\_\_\_\_ (TELEPHONE) \_\_\_\_\_

ADDRESS \_\_\_\_\_

CITY \_\_\_\_\_ STATE \_\_\_\_\_ ZIP \_\_\_\_\_

SERVICE CO.  OEM  MANUFACTURER  DEALER  VAR/VAD

IN-HOUSE SERVICE  USER OTHER \_\_\_\_\_

ES&T 0188

Zenith remanufactured and reconditioned  
replacement modules and sub-assemblies

# factory-fresh from Exchange Counters throughout the U.S.

There's no sense risking  
an exchange anywhere else!

One of the easiest, fastest, and surest ways for you to preserve the pedigree of the Zenith products you service and maintain is with genuine Zenith replacement parts.

And at no time is this more critical than when you replace the more sophisticated components like modules, tuners, channel selectors and sub-assemblies.

Your participating Zenith parts distributor will supply you with a replacement remanufactured, reconditioned and serviced for reliability by Zenith people as dedicated and knowledgeable as those who made the original.

Equally important, the replacement module or sub-assembly you receive in exchange from your Zenith parts distributor will most likely incorporate Zenith factory modifications, if any, in effect at the time of remanufacture.

**And nowhere else but in a participating Zenith parts distributor's Exchange Program can you get assurance that a replacement incorporates a Zenith factory up-date if one exists!**

**ZENITH**  
®

*The quality goes in before the name goes on.®*

That's why you should start taking advantage of your Zenith parts distributor's R&R Exchange Program now.

We'll help you locate the Zenith R&R Exchange Counters in your area if you'll write on your company letterhead with your complete address element and Zip Code.

Chances are there's an Exchange Counter for Zenith factory-fresh replacement modules and sub-assemblies closer than you realize.

Write, if you don't know, and we'll tell you where it is! There's no sense risking an exchange for a Zenith replacement anywhere else!